



ZUMTOBEL



*The Lighting Handbook*

Your concise reference book



Chapter 1  
**Lighting technology**

Chapter 2  
**Standard values for indoor and outdoor lighting**  
Based on the new European standards

Chapter 3  
**Lighting application**

Chapter 4  
**Technology**

Chapter 5  
**Lamps**

Chapter 6  
**Lighting control and control gear**

Chapter 7  
**Emergency lighting**

Chapter 8  
**Technology and tables**

Chapter 9  
**Design tools**

*Imprint*

For questions and suggestions on  
**“The Lighting Handbook”**

Zumtobel Lighting GmbH  
Schweizer Strasse 30  
Postfach 72  
6851 Dornbirn, AUSTRIA  
T +43/(0)5572/390-0  
info@zumbobel.info



## Lighting technology

<b>What is light?</b>	6
What does the human eye see?	7
Human Centric Lighting	8
Light has a triple effect	8
<b>Basic parameters used in lighting</b>	10
Luminous flux	11
Luminous intensity	11
Illuminance	11
Luminance	11
<b>Quality characteristics of lighting</b>	
The right light – traditional and new quality criteria	12
Illuminance – definition of terminology	12
Glare – glare limitation	14
The UGR method	15
Illuminance levels on ceilings and walls	17
Spatial illumination	17
Light colour	18
Colour rendering	18
<b>Measuring illuminance</b>	19
<b>Outdoor lighting</b>	20
<b>Types of lighting</b>	22
<b>Lighting concepts</b>	24
<b>Energy efficiency in buildings</b>	26

## What is light?

Light is that part of the electromagnetic spectrum that is perceived by our eyes. The wavelength range is between 380 and 780 nm. The cones come on during the day and we see colours, whereas at night the rods take over and we only see shades of grey.

### What is the melanopic effect of light?

The retina also contains photosensitive ganglion cells. These are sensitive to blue light and suppress the sleep hormone melatonin at night. Melatonin is responsible for a good sleep at night. Melatonin is responsible for a good sleep at night. Suppressing melatonin in the morning helps keep you awake during the day. This means that the right light controls the circadian rhythm thus a healthy waking and sleeping behaviour.

### What is light?

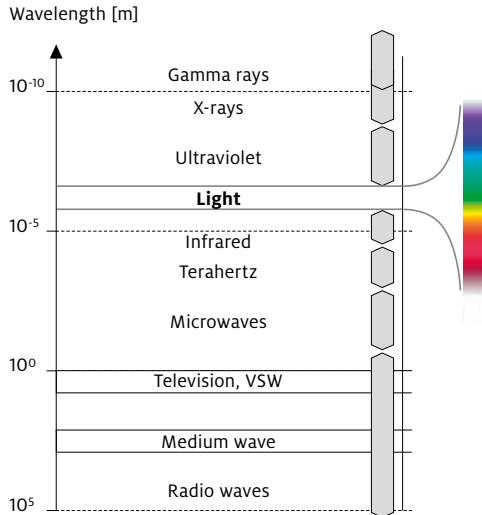

What does the human eye see?

### Relative spectral perception of brightness and melanopic effect

Effect as a percentage

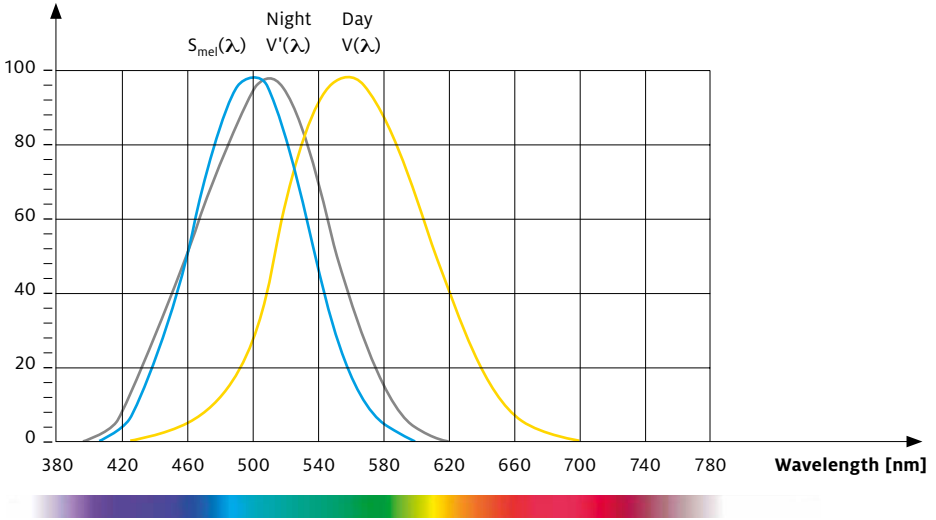

Explanation of the three curves:

$V(\lambda)$  = Perception of brightness, daytime seeing with the cones

$V'(\lambda)$  = Night-time seeing with the rods

$S_{mel}(\lambda)$  = Melatonin suppression with the photosensitive ganglion cells

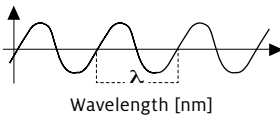

**What is light?**

## Human Centric Lighting

Human Centric Lighting (HCL) expresses the positive effect of light and lighting on the health, well-being and performance of humans and thus has both short and long-term benefits.

### Light has a triple effect

Light for **visual** functions

- Illumination of task area in conformity with relevant standards
- Glare-free and convenient

Light for **emotional** perception

- Lighting enhancing architecture
- Creating scenes and effects

Light creating **biological** effects

- Supporting people's circadian rhythm
- Stimulating or relaxing



## Basic parameters used in lighting

Luminous flux – Luminous intensity – Illuminance – Luminance

### Luminous flux $\Phi$

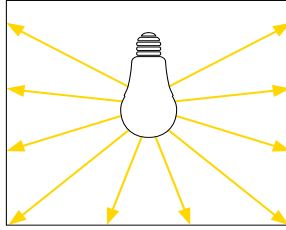

$$I = \frac{\Phi}{\Omega}$$

$$E = \frac{\Phi}{A}$$

Lumen [lm]

### Luminous intensity I

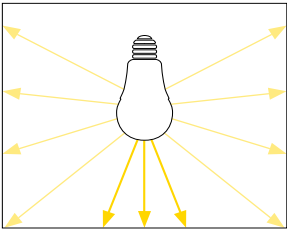

Candela [lm/sr]=[cd]

### Illuminance E

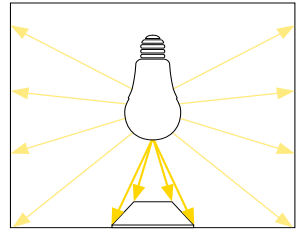

Lux [lm/m²]=[lx]

### Luminance L

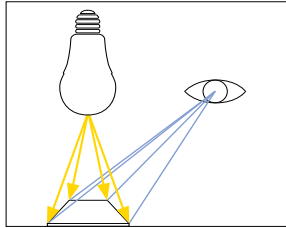

[lm/sr\*m²]=[cd/m²]

$$L = \frac{I}{A_L \cdot \cos\epsilon}$$

$$L = \frac{E \cdot \rho^*}{\pi}$$

$\Omega$  = solid angle into which luminous flux is emitted

A = area hit by luminous flux

$A_L \cdot \cos\epsilon$  = visible areas of light source

$\rho$  = reflectance of area

$\pi$  = 3.14

\* = for diffuse surface areas

## Luminous flux

The *luminous flux* describes the quantity of light emitted by a light source.

The *luminous efficiency* is the ratio of the luminous flux to the electrical power consumed (lm/W). It is a measure of a light source's economic efficiency.

**Abbreviation:**  $\Phi$  **Phi** **Unit:** lm **Lumen**

## Luminous intensity

The *luminous intensity* describes the quantity of light that is radiated in a particular direction. This is a useful measurement for directive lighting elements such as reflectors. It is represented by the *luminous intensity distribution curve* (LDC).

**Abbreviation:** I **Unit:** cd **Candela**

## Illuminance

*Illuminance* describes the quantity of luminous flux falling on a surface. Relevant standards specify the required illuminance (e.g. EN 12464 "Lighting of indoor workplaces").

$$\text{Illuminance: } E(\text{lx}) = \frac{\text{luminous flux (lm)}}{\text{area (m}^2\text{)}}$$

**Abbreviation:** E **Unit:** lx **Lux**

## Luminance

*Luminance* is the only basic lighting parameter that is perceived by the eye.

It describes on the one hand a light source's impression of brightness, and on the other, a surface and therefore depends to a large extent on the degree of reflection (colour and surface).

**Abbreviation:** L **Unit:** cd/m<sup>2</sup>



## Quality characteristics of lighting

The right light – traditional and new quality criteria

### Traditional quality criteria

- Sufficient illumination level
- Harmonious brightness distribution
- Glare limitation
- Avoidance of reflections
- Good modelling
- Correct light colour
- Appropriate colour rendering

### New quality criteria

- Changing lighting situations
- Personal control
- Energy efficiency
- Daylight integration
- Light as an interior design element

Illuminance – definition of terminology

### Illuminance maintenance value $\bar{E}_m$

Value below which the illuminance level must not fall in the visual task area.

### Visual task area

Illuminance levels are specified for specific visual tasks and are designed for the area in which these may take place.

If the exact location is unknown, the room as a whole or a defined area of the workstation is used for specification.

The visual task area may be a horizontal, vertical or inclined plane.

### Area immediately surrounding the visual task area

Here illuminance may be one level lower than in the visual task area (e.g. 300 lx to 500 lx).

### Maintenance factor

The initial value multiplied by the maintenance factor gives the illuminance maintenance value.

The maintenance factor can be determined individually, and takes the installation's reduction in luminous flux caused by soiling and ageing of lamps, luminaires and room surfaces into account.

The maintenance schedule (the cleaning and maintenance intervals for the lamps and installation) must be documented.

See also Section 9 – Checklists.

### Uniformity $U_0$

In order to perform visual tasks in illuminated areas, there should not be any great differences in brightness so that uniformity should not fall below  $U_0 = E_{\min}/\bar{E}$ .



### Relative illuminance (%)

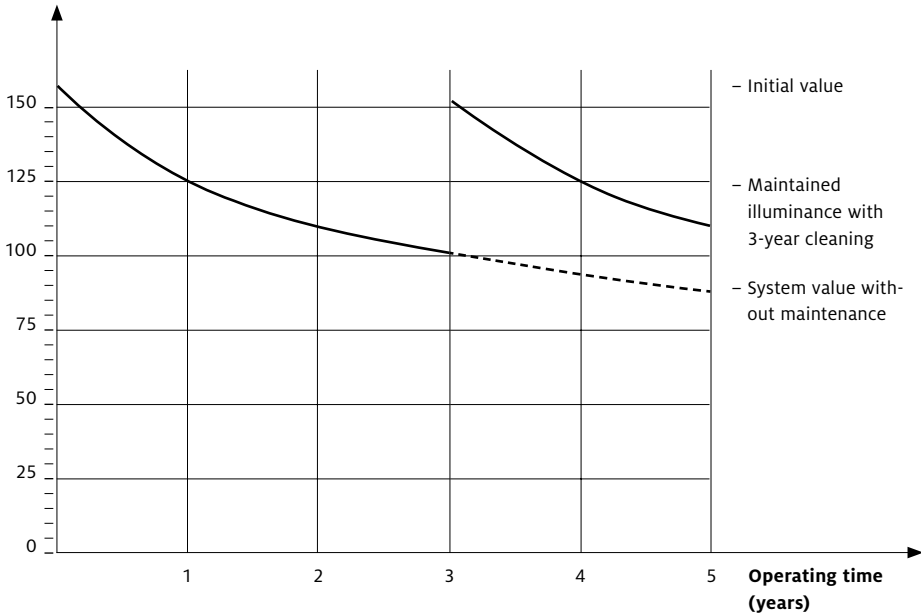

Maintenance value = maintenance factor x initial value

### Reflectance factors

The reflectance factors of the room and object surfaces determine not only the perception of the room but also the reflected light and thus the room's brightness.

The reflectance factor table in the system helps you determine the reflectance factors.

## Glare – glare limitation

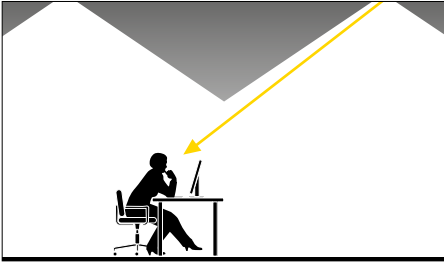
**Direct glare***Cause*

- Luminaires without glare control
- Very bright surfaces

*Effect*

- Loss of concentration
- More frequent mistakes
- Fatigue

*Remedy*

- Luminaires with limited luminance levels
- Blinds on windows

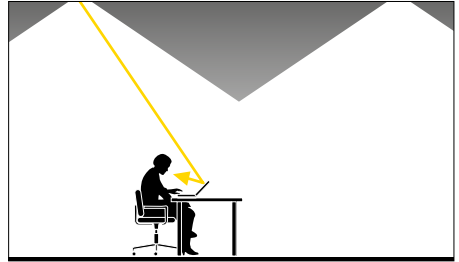
**Reflected glare***Cause*

- Reflective surfaces
- Incorrect luminaire arrangement
- Incorrect workstation position

*Effect*

- Loss of concentration
- More frequent mistakes
- Fatigue

*Remedy*

- Matching luminaire to workstation (layout)
- Indirect lighting
- Matt surfaces

**The evaluation of glare**

The glare of all luminaires that are in the room regularly can be evaluated with the UGR method, as specified in the standard EN 12464-1 “Lighting of indoor workplaces”. However LED luminaires with very bright light points, which can be perceived individually, are crucial.

**Classic VDU workstation luminaires**

The standard requires the luminance of the luminaire to be below 3000 or 1500 cd/m<sup>2</sup> at an angle of 65°.

## The UGR method

The standardised UGR method (unified glare rating) is used to assess (psychological) glare. The UGR value is calculated with a formula.

This takes into account all of the luminaires in the system that contribute to the impression of glare. The UGR values for luminaires are determined using the table method pursuant to CIE 117. Zumtobel quotes both a UGR reference value for a reference room and the UGR tables for other room sizes for the majority of luminaires in its data sheets and on their website.

The UGR tables are available for each luminaire via the respective photometric data sheet: Select a product → Photometry → Select a layout

The values are hereby used for a classification on a glare level. A comparison of individual values does not allow any statement. Example: 18.5 is  $\leq 19$  (level) but not better than 19.0 (same glare level  $\leq 19$ ).

Note: the glare value  $R_g$  is used outdoors. It is explained in the standard EN 12464-2.

### UGR limits ( $UGR_{lim}$ ) that must not be exceeded:

- $\leq 16$  Technical drawing
- $\leq 19$  Reading, writing, training, meetings, computer-based work
- $\leq 22$  Craft and light industries
- $\leq 25$  Heavy industry
- $\leq 28$  Railway platforms, foyers

The UGR limits are specified in the EN 12464 standard for activities and visual tasks (see tables on pages 31–41).

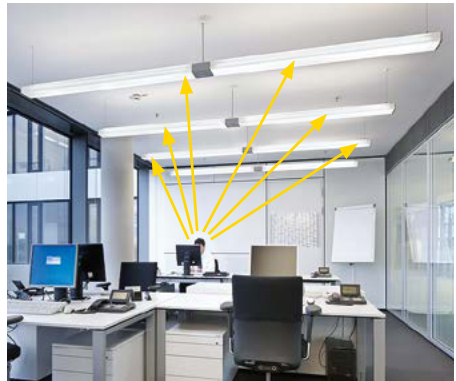

$$UGR = 8 \log \left( \underbrace{0,25}_{(1)} \sum \underbrace{\frac{L^2 \Omega}{p^2}}_{(2)} \right)$$

The UGR method takes account of the brightness of walls and ceilings (1) as well as all luminaires in the system that contribute to the sensation of glare (2). The result is a UGR index.

Quality characteristics of lighting

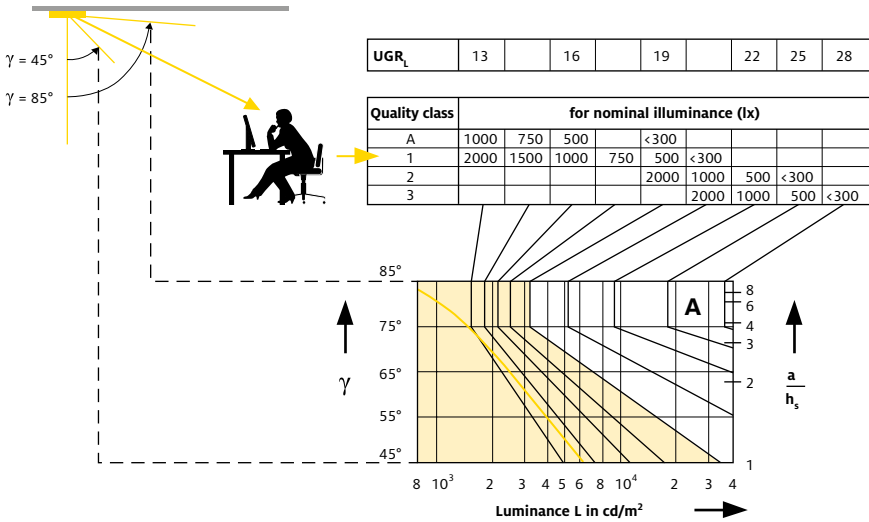

The luminance limit curve method assesses the mean luminance of a luminaire from a viewing angle of 45° to 85°.

The new European standard sets UGR = 19 as the maximum permissible value for offices, which is equivalent to the luminance limiting curve for 500 lx in Quality class 1.

The limit value method was used in the former standard DIN 5035 to assess the glare.

## Illuminance levels on ceilings and walls

Unlit ceilings and walls create an unpleasant room impression. Bright surfaces, however, pleasantly enhance the room climate.

The EN 12464 standard therefore requires an illuminance level of at least 30 lx or 50 lx\* on ceilings and at least 50 lx or 75 lx\* on walls. In fact, these levels ought to be significantly exceeded and should be at least 175 lx on walls.

\* in offices, class rooms, hospitals



## Spatial illumination

In order to enhance people's and objects' recognisability in a room, basic requirements are placed on cylindrical illuminance  $\bar{E}_z$  and modelling.

Hence,  $\bar{E}_z$  should be as high as 150 lx in rooms used for communication.

Modelling is the ratio between cylindrical and horizontal illuminance at a specific point and should be between 0.3 and 0.6.

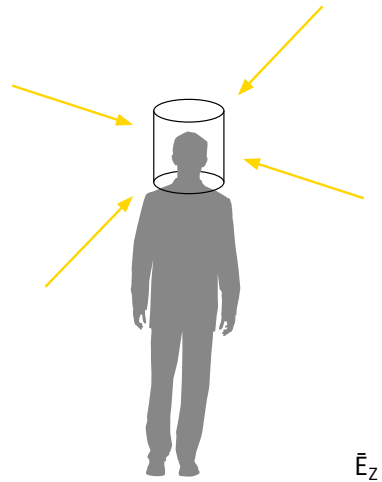

## Quality characteristics of lighting

### Light colour

The light colour describes the colour appearance of the light.

	Colour temperature	Appearance	Association
<b>ww</b> (warm white)	up to 3300 K	reddish	warm
<b>nw</b> (intermediate white)	3300–5300 K	white	neutral
<b>tw</b> (cool white)	from 5300 K	bluish	cool

In addition to the colours of the surfaces, it is also the light colour that determines a room's basic atmosphere!

Please refer to Chapter 4 – Technology for light colours of light sources and changes to the light colour.

### Colour rendering

Colour rendering is the ability of a light source to reproduce surface colours (8 test colours  $R_1$  to  $R_8$ ) as faithfully as possible compared to a reference light source. It is identified by the colour rendering index (CRI). The best colour rendering is  $R_a = 100$ .

Light sources are divided up into colour rendering levels:

$R_a > 90$  very good colour rendering

$R_a > 80$  good colour rendering

Colour rendering of less than 80 should not be selected at workplaces.

If light sources with a colour rendering index below 80 are used in exceptional cases, it has to be ensured that safety colours can be recognised without any problems.

The saturated test colours  $R_9$  to  $R_{14}$  are also used occasionally to describe special functions of a light source. The reproduction of these colours is then quoted separately.

Light <b>R<sub>1</sub></b> greyish red		Light <b>R<sub>5</sub></b> blueish green	
Dark <b>R<sub>2</sub></b> greyish yellow		<b>R<sub>6</sub></b> Light blue	
Strong <b>R<sub>3</sub></b> yellow green		<b>R<sub>7</sub></b> Light violet	
Moderate <b>R<sub>4</sub></b> yellowish green		Light <b>R<sub>8</sub></b> reddish purple	
<b>R<sub>9</sub></b> Strong red		<b>R<sub>12</sub></b> Strong blue	
<b>R<sub>10</sub></b> Strong yellow		Light <b>R<sub>13</sub></b> yellowish pink	
<b>R<sub>11</sub></b> Strong green		Moderate <b>R<sub>14</sub></b> olive green (leaf)	

## Measuring illuminance

The Mean illuminance is the arithmetic brilliance level measured with a luxmeter in a defined grid, under precisely specified conditions.

### Measuring instruments:

#### Description and precision

- L: maximum precision, tolerance 3%
- A: high precision, tolerance 5%
- B: average precision; tolerance 10% (minimum requirement)

#### Measuring conditions

- Avoid external light/daylight (measure separately and subtract)
- Check mains voltage and ambient temperature
- Use new, burnt-in lamps (discharge lamps 100 h)

### Measuring grid and measuring level

In order to facilitate inspection of the lighting system, the measuring grid has been specified in the EN 12464 (Lighting of workplaces) and EN 12193 (Lighting of sports facilities) standards.

The following recommendations apply for the height of the measuring levels:

- Workplaces = 0.75 m;  
sports facilities (floor) = 0.03 m
- Circulation areas, stairs,  
car parks (floor) = 0.03 m
- Cylindrical illuminance = 1.2 m
- Measuring grid: congruent triangles
- Measuring grid not congruent with luminaire layout grid

Size of measuring field	Grid element spacing
1 m	0.2 m
5 m	0.6 m
10 m	1 m
50 m	3 m
100 m	5 m

## Outdoor lighting

The following aspects have to be taken into account for the illumination of squares and parks, buildings and facades:

- targeted illumination of the areas to be visualised, both horizontal and vertical
- creation of a three-dimensional perception of the room through different brightness levels and shades
- balanced brightness distribution
- avoidance of strong dark-light contrasts
- limitation of the glare effect for residents and passers-by
- choose matching light colour and colour rendering
- no unused stray light
- when illuminating horizontal areas:
  - no light emission in the upper half of the room

Darkness has to be respected at night.



In order to restrict the interfering effect, EN 12464-2 specifies the luminous intensities and luminances quoted in the table for outdoor spaces:

### Maximum permissible interference effects of outdoor lighting systems

Environ- mental zone	Light at the place of immission		Luminous intensity of the luminaire		Share of light pointing upwards	Luminance		
	$E_v$		$I$			$R_{UL}$	$L_b$	$L_s$
	lx		cd			%	cd/m <sup>2</sup>	cd/m <sup>2</sup>
	before enforce- ment time*	after enforce- ment time	before enforce- ment time*	after enforce- ment time		Building facade	Signs	
E1	2	0	2500	0	0	0	50	
E2	5	1	7500	500	5	5	400	
E3	10	2	10000	1000	15	10	800	
E4	25	5	25000	2500	25	25	1000	

E1 Dark areas such as national parks or protected places

E2 Areas with little local brightness, such as industrial or residential areas in rural surroundings

E2 Areas with moderate local brightness, such as industrial or residential areas in suburbs

E4 Areas of high local brightness, such as city centres and commercial centres

$E_v$  is the maximum vertical luminous intensity at the place of immission in lx

$I$  is the luminous intensity of each individual light source in the potential direction of interference in cd

$R_{UL}$  is the share of the light output of the luminaire(s) radiated above the horizontal plane with the luminaire(s) in its/their installed position and location in %

$L_b$  is the highest mean luminance of a building's facade in cd/m<sup>2</sup>

$L_s$  is the highest mean luminance of signs in cd/m<sup>2</sup>

\* In the event that there is no enforcement time, the higher values may not be exceeded and the lower values should preferably be taken as limit values

## Types of lighting

### Direct lighting



- Light falls from the luminaires on the ceiling directly onto the workplace, in part highly directional
- Glare suppression is important under flat angles
- The ceiling can appear dark (cave effect)
- The workplace layout should not allow any shadows
- High energy efficiency is achieved for the work area

### Indirect lighting



- Light is directed to the ceiling and walls so that it illuminates the workplaces indirectly
- The lighting effect may appear diffuse through the absence of shadows
- The room increases in height
- The light is glare-free
- Workplaces can be arranged at random
- Lower energy efficiency



### Indirect/direct lighting

- Light is directed to the workplace directly and indirectly via the ceiling from suspended luminaires or free-standing luminaires
- Pleasant room visuals
- High user acceptance
- Good contrast ratios
- Flexible workplace layout with an indirect share of > 60%
- Good combination of energy efficiency and lighting quality



### Mellow Light

- The advantages of direct-indirect lighting are combined in a ceiling-mounted luminaire
- Possibility of a free workplace layout
- Glare-free lighting that looks good make for a high acceptance
- Gives impression of daylight in a room
- Good combination of energy efficiency and lighting quality

## Lighting concepts

The definition of individual visual tasks for the purpose of lighting design in a room, as provided for in the EN 12464 standard, opens up new perspectives for lighting design. The quantity and quality of light can now be specified exactly for any task area.

Task area related lighting concepts are a customised tool to fully exploit the additional options provided. At the same time they offer financial scope that can be used to improve lighting comfort and enhance the effect of a room.

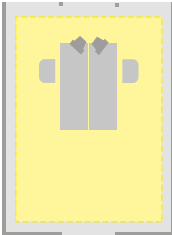

Room-related lighting concepts take neither individual task areas nor different visual tasks into account. They are based on the most demanding task performed in the room. The position of the workstation is not defined, the entire room disposes of a uniform lighting quality.

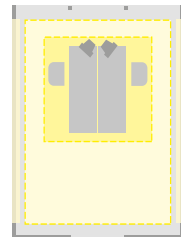

Lighting focussed onto individual visual task areas provides for varied light design in the room. By illuminating walls, for instance, rooms can be designed to be much more open and attractive; dynamic lighting situations can enhance their visual quality.

## Energy efficiency in buildings

The energy requirement of the lighting is also determined when issuing an energy performance certificate pursuant to the European Energy Performance of Buildings Directive.

The LENI (Lighting Energy Numeric Indicator) stands for the actual energy

consumption of a lighting system in kWh per square metre and year.

The LENI is determined in accordance with the specifications of the EN 15193 standard (Energy performance of buildings – Energy requirements for lighting).

### Formula for calculating a lighting installation's energy consumption

$$\text{LENI} = \frac{\sum (P_n \times F_C) \times \{(t_D \times F_D \times F_O) + (t_N \times F_O)\}}{A} \quad [\text{kWh}/(\text{m}^2 \text{ year})]$$

Without elaborating on individual parameters in greater detail, the following relevant factors are identified:

- The installed load ( $P_n$ )
- Multiplied by the annual hours of use by day ( $t_D$ ) and at night ( $t_N$ )
- Reduced by the factors ( $\leq 1$ ) for daylight-based control ( $F_D$ ), presence-based control ( $F_O$ ) and a constant lighting control system ( $F_C$ ) (e.g. maintenance control)
- The area assessed ( $A$ )

LENI also takes charging energy for emergency lighting and standby energy into account.

**The following factors have a positive impact on the reduction of energy consumption**

- Sensible control of lighting
- Use of daylight
- Use of presence detectors
- Intelligent consideration of hours of use
- Energy-efficient lamps
- Need-based use of luminaires and lighting solutions, specified for the respective application
- Constant lighting control (maintenance control)





---

**Standard values for lighting of indoor and outdoor workplaces  
and sports facility lighting** 30

---

**Indoor workplaces**

Traffic zones and general areas inside buildings	31
Industrial activities and crafts	31
Offices	36
Retail premises	36
Places of public assembly	36
Educational premises	37
Health care premises	37
Transportational areas	39
Sports facilities	40

---

**Outdoor workplaces**

General circulation areas	42
Airports	42
Building sites	42
Fuel filling service stations	42
Industrial sites and storage areas	42
Offshore facilities for gas and oil extraction	43
Parking areas	43
Petrochemical and other hazardous industries	43
Power, electricity, gas and heat plants	43
Railway and tramways	44
Saw mills	44

---

## Standard values for lighting of indoor and outdoor workplaces and sports facility lighting

Tables and figures were taken from the European standards.

### “Lighting of indoor workplaces”,

#### EN 12464-1

(June 2011)

### “Lighting of outdoor workplaces”,

#### EN 12464-2

(October 2007)

### “Sports facility lighting”, EN 12193

(April 2008)

**The following limits have been specified in the tables:**

**Illuminance levels** must not fall below the  $\bar{E}_m$  **maintenance values** in the visual task area. If the precise location is not known, the limit should be applied to the whole room or a specific working area.

Example for an office task area:

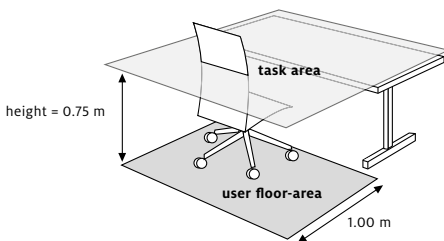

**The maintenance factors** can be determined on a case-by-case basis, according to the manufacturer’s specifications.

Where no individual maintenance data is available, the following values are recommended as reference maintenance factors for modern technology and three-yearly maintenance: *0.67 in a clean atmosphere, and 0.50 in very dirty environments.*

EN 12464 specifies that the lighting designer must document the maintenance factor and maintenance schedule.

$UGR_L$  is the upper limit for direct glare. The UGR value calculated in the design process must lie below this.

Uniformity  $U_o$  is the ratio between the lowest ( $E_{min}$ ) and the mean illuminance level ( $\bar{E}$ ) in the area to be evaluated. The result is a minimum level.

$R_a$  is the lower limit for the colour rendering index. The  $R_a$  of the selected lamp must be equal to or greater than this value.

## Type of interior, task or activity

### Traffic zones and general areas inside buildings

		$\dot{E}_m$	UGR <sub>L</sub>	U <sub>O</sub>	R <sub>a</sub>
Circulation areas within buildings	Circulation areas and corridors	100	28	0.4	40
	Stairs, escalators, moving walkways	100	25	0.4	40
	Elevators, lifts	100	25	0.4	40
	Loading ramps/bays	150	25	0.4	40
Rest, sanitation and first aid rooms	Canteens, pantries	200	22	0.4	80
	Rest rooms	100	22	0.4	80
	Rooms for physical exercise	300	22	0.4	80
	Cloakrooms, washrooms, bathrooms, toilets	200	25	0.4	80
	Sick bays	500	19	0.6	80
	Rooms for medical attention	500	16	0.6	90
Control rooms	Plant rooms, switch gear rooms	200	25	0.4	60
	Telex, post room, switchboard	500	19	0.6	80
Store rooms, cold stores	Store and stockrooms	100	25	0.4	60
	Dispatch packing handling areas	300	25	0.6	60
Storage rack areas	Gangways: unmanned	20	-	0.4	40
	Gangways: manned	150	22	0.4	60
	Control stations	150	22	0.6	80
	Front of (high-bay) racks	200	-	0.4	60

### Industrial activities and crafts

Agriculture	Loading and operating of goods, handling equipment and machinery	200	25	0.4	80
	Buildings for livestock	50	-	0.4	40
	Sick animal pens; calving stalls	200	25	0.6	80
	Feed preparation; dairy; utensil washing	200	25	0.6	60
Bakeries	Preparation and baking	300	22	0.6	80
	Finishing, glazing, decorating	500	22	0.7	80
Cement, cement goods, concrete, bricks	Drying	50	28	0.4	20
	Preparation of materials; work on kilns and mixers	200	28	0.4	40
	General machine work	300	25	0.6	80
	Rough forms	300	25	0.6	80
Ceramics, tiles, glass, glassware	Drying	50	28	0.4	20
	Preparation, general machine work	300	25	0.6	80
	Enamelling, rolling, pressing, shaping simple parts, glazing, glass blowing	300	25	0.6	80
	Grinding, engraving, glass polishing, shaping precision parts, manufacture of glass instruments	750	19	0.7	80
	Grinding of optical glass, crystal, hand grinding and engraving	750	16	0.7	80
	Precision work e.g. decorative grinding, hand painting	1000	16	0.7	90
	Manufacture of synthetic precious stones	1500	16	0.7	90

## Indoor workplaces

## Type of interior, task or activity

## Industrial activities and crafts

	$\dot{E}_m$	UGR <sub>L</sub>	U <sub>0</sub>	R <sub>a</sub>
Chemical, plastics and rubber industry				
Remote-operated processing installations	50	–	0.4	20
Processing installations with limited manual intervention	150	28	0.4	40
Constantly manned work places in processing installations	300	25	0.6	80
Precision measuring rooms, laboratories	500	19	0.6	80
Pharmaceutical production	500	22	0.6	80
Tyre production	500	22	0.6	80
Colour inspection	1000	16	0.7	90
Cutting, finishing, inspection	750	19	0.7	80
Electrical industry				
Cable and wire manufacture	300	25	0.6	80
Winding:				
– large coils	300	25	0.6	80
– medium-sized coils	500	22	0.6	80
– small coils	750	19	0.7	80
Coil impregnating	300	25	0.6	80
Galvanising	300	25	0.6	80
Assembly work:				
– rough e.g. large transformers	300	25	0.6	80
– medium e.g. switchboards	500	22	0.6	80
– fine e.g. telephones, radios, IT products (computers)	750	19	0.7	80
– precision e.g. measuring equipment, printed circuit boards	1000	16	0.7	80
Electronic workshops, testing, adjusting	1500	16	0.7	80
Food stuffs and luxury food industry				
Work places and zones in:				
– breweries, malting floors				
– for washing, barrel filling, cleaning, sieving, peeling				
– cooking in preserve and chocolate factories				
– work places and zones in sugar factories				
– for drying and fermenting raw tobacco, fermentation	200	25	0.4	80
Sorting and washing of products, milling, mixing, packing	300	25	0.6	80
Work places and critical zones in slaughter houses, butchers, dairies mills, on filtering floor in sugar refineries	500	25	0.6	80
Cutting and sorting of fruit and vegetables	300	25	0.6	80
Manufacture of delicatessen foods, kitchen work, manufacture of cigars and cigarettes	500	22	0.6	80
Inspection of glasses and bottles, product control, trimming, sorting, decoration	500	22	0.6	80
Laboratories	500	19	0.6	80
Colour inspection	1000	16	0.7	90

## Type of interior, task or activity

### Industrial activities and crafts

		$\dot{E}_m$	UGR <sub>L</sub>	U <sub>O</sub>	R <sub>a</sub>
Foundries and metal casting	Man-size underfloor tunnels, cellars, etc.	50	–	0.4	20
	Platforms	100	25	0.4	40
	Sand preparation	200	25	0.4	80
	Dressing rooms	200	25	0.4	80
	Workstations at cupola furnaces and mixers	200	25	0.4	80
	Casting bays	200	25	0.4	80
	Shake out areas	200	25	0.4	80
	Machine moulding	200	25	0.4	80
	Hand and core moulding	300	25	0.6	80
	Die casting	300	25	0.6	80
	Model building	500	22	0.6	80
Hairdressers	Hairdressing	500	19	0.6	90
Jewellery manufacturing	Working with precious stones	1500	16	0.7	90
	Manufacture of jewellery	1000	16	0.7	90
	Watch making (manual)	1500	16	0.7	80
	Watch making (automatic)	500	19	0.6	80
Laundries and dry cleaning	Goods in, marking and sorting	300	25	0.6	80
	Washing and dry cleaning	300	25	0.6	80
	Ironing, pressing	300	25	0.6	80
	Inspection and repairs	750	19	0.7	80
Leather and leather goods	Work on vats, barrels, pits	200	25	0.4	40
	Fleshing, skiving, rubbing, tumbling of skins	300	25	0.4	80
	Saddlery work, shoe manufacture: stitching, sewing, polishing, shaping, cutting, punching	500	22	0.6	80
	Sorting	500	22	0.6	90
	Leather dyeing (machine)	500	22	0.6	80
	Quality control	1000	19	0.7	80
	Colour inspection	1000	16	0.7	90
	Shoe making	500	22	0.6	80
	Glove making	500	22	0.6	80
Metal working and processing	Open die forging	200	25	0.6	80
	Drop forging	300	25	0.6	80
	Welding	300	25	0.6	80
	Rough and average machining: tolerances $\geq 0.1$ mm	300	22	0.6	80
	Precision machining; grinding: tolerances $< 0.1$ mm	500	19	0.7	80
	Scribing, inspection	750	19	0.7	80
	Wire and pipe drawing shops; cold forming	300	25	0.6	80
	Plate machining: thickness $\geq 5$ mm	200	25	0.6	80
	Sheet metalwork: thickness $< 5$ mm	300	22	0.6	80
	Tool making; cutting equipment manufacture	750	19	0.7	80

## Indoor workplaces

## Type of interior, task or activity

## Industrial activities and crafts

	$\dot{E}_m$	UGR <sub>L</sub>	U <sub>0</sub>	R <sub>a</sub>	
Metal working and processing	Assembly:				
	– rough	200	25	0.6	80
	– medium	300	25	0.6	80
	– fine	500	22	0.6	80
	– precision	750	19	0.7	80
	Galvanising	300	25	0.6	80
	Surface preparation and painting	750	25	0.7	80
Paper and paper goods	Tool, template and jig making, precision mechanics, micromechanics	1000	19	0.7	80
	Edge runners, pulp mills	200	25	0.4	80
	Paper manufacture and processing, paper and corrugating machines, cardboard manufacture	300	25	0.6	80
Power stations	Standard bookbinding work, e.g. folding, sorting, glueing, cutting, embossing, sewing	500	22	0.6	80
	Fuel supply plants	50	–	0.4	20
	Boiler houses	100	28	0.4	40
	Machine halls	200	25	0.4	80
	Side rooms, e.g. pump rooms, condenser rooms etc.; switchboards (inside buildings)	200	25	0.4	60
Printers	Control rooms	500	16	0.7	80
	Cutting, gilding, embossing, block engraving, work on stones and platens, printing machines, matrix making	500	19	0.6	80
	Paper sorting and hand printing	500	19	0.6	80
	Type setting, retouching, lithography	1000	19	0.7	80
	Colour inspection in multicoloured printing	1500	16	0.7	90
Rolling mills, iron and steel works	Steel and copper engraving	2000	16	0.7	80
	Production plants without manual operation	50	–	0.4	20
	Production plants with occasional manual operation	150	28	0.4	40
	Production plants with continuous manual operation	200	25	0.6	80
	Slab storage facilities	50	–	0.4	20
	Furnaces	200	25	0.4	20
	Mill trains; coilers; shear lines	300	25	0.6	40
	Control platforms; control panels	300	22	0.6	80
	Test, measurement and inspection	500	22	0.6	80
Underfloor man-sized tunnels; belt sections; cellars etc.	50	–	0.4	20	
Textile manufacture and processing	Work places and zones in baths, bale opening	200	25	0.6	60
	Carding, washing, ironing, devilling machine work, drawing, combing, sizing, card cutting, pre-spinning, jute and hemp spinning	300	22	0.6	80
	Spinning, plying, reeling, winding	500	22	0.6	80

## Type of interior, task or activity

### Industrial activities and crafts

		$\dot{E}_m$	UGR <sub>L</sub>	U <sub>O</sub>	R <sub>a</sub>
Textile manufacture and processing	Warping, weaving, braiding, knitting	500	22	0.6	80
	Sewing, fine knitting, taking up stitches	750	22	0.7	80
	Manual design, drawing patterns	750	22	0.7	90
	Finishing, dyeing	500	22	0.6	80
	Drying room	100	28	0.4	60
	Automatic fabric printing	500	25	0.6	80
	Burling, picking, trimming	1000	19	0.7	80
	Colour inspection; fabric control	1000	16	0.7	90
	Invisible mending	1500	19	0.7	90
	Hat manufacturing	500	22	0.6	80
	Vehicle construction and repair	Body work and assembly	500	22	0.6
Painting, spraying chamber, polishing chamber		750	22	0.7	80
Painting: touch-up, inspection		1000	19	0.7	90
Upholstery manufacture (manned)		1000	19	0.7	80
Final inspection		1000	19	0.7	80
General vehicle servicing, repair and inspection		300	22	0.6	80
Wood working and processing	Automatic processing e.g. drying, plywood manufacturing	50	28	0.4	40
	Steam pits	150	28	0.4	40
	Saw frames	300	25	0.6	60
	Work at joiner's bench, glueing, assembly	300	25	0.6	80
	Polishing, painting, fancy joinery	750	22	0.7	80
	Work on wood working machines e.g. turning, fluting, dressing, rebating, grooving, cutting, sawing, sinking	500	19	0.6	80
	Selection of veneer woods	750	22	0.7	90
	Marquetry, inlay work	750	22	0.7	90
	Quality control, inspection	1000	19	0.7	90

## Indoor workplaces

## Type of interior, task or activity

Offices		$\dot{E}_m$	UGR <sub>L</sub>	U <sub>O</sub>	R <sub>a</sub>
	Filing, copying, etc.	300	19	0.4	80
	Writing, typing, reading, data processing	500	19	0.6	80
	Technical drawing	750	16	0.7	80
	CAD work stations	500	19	0.6	80
	Conference and meeting rooms	500	19	0.6	80
	Reception desks	300	22	0.6	80
	Archives	200	25	0.4	80
<b>Retail premises</b>					
	Sales areas	300	22	0.4	80
	Till areas	500	19	0.6	80
	Wrapper tables	500	19	0.6	80
<b>Places of public assembly</b>					
General areas	Entrance halls	100	22	0.4	80
	Cloakrooms	200	25	0.4	80
	Lounges	200	22	0.4	80
	Ticket offices	300	22	0.6	80
Restaurants and hotels	Reception/cashier desks, porters desks	300	22	0.6	80
	Kitchens	500	22	0.6	80
	Restaurant, dining room, function room	-	-	-	80
	Self-service restaurants	200	22	0.4	80
	Buffets	300	22	0.6	80
	Conference rooms	500	19	0.6	80
	Corridors	100	25	0.4	80
Theatres, concert halls, cinemas	Practice rooms	300	22	0.6	80
	Dressing rooms	300	22	0.6	90
	Seating areas – maintenance, cleaning	200	22	0.5	80
	Stage areas – construction	300	25	0.4	80
Trade fairs, exhibition halls	General lighting	300	22	0.4	80
Museums	Exhibits, insensitive to light				according to requirements
	Light-sensitive exhibits				
Libraries	Bookshelves	200	19	0.4	80
	Reading areas	500	19	0.6	80
	Counters	500	19	0.6	80
Public car parks (indoor)	In/out ramps (during the day)	300	25	0.4	40
	In/out ramps (at night)	75	25	0.4	40
	Traffic lanes	75	25	0.4	40
	Parking areas	75	-	0.4	40
	Ticket offices	300	19	0.6	80



## Type of interior, task or activity

### Educational premises

		$\dot{E}_m$	UGR <sub>L</sub>	U <sub>O</sub>	R <sub>a</sub>
Nursery school, play school	Play rooms	300	22	0.4	80
	Nurseries	300	22	0.4	80
	Handicraft rooms	300	19	0.6	80
Educational buildings	Classrooms, tutorial rooms	300	19	0.6	80
	Classrooms for evening classes and adults education	500	19	0.6	80
	Lecture halls	500	19	0.6	80
	Black, green wallboards and whiteboards	500	19	0.7	80
	Demonstration tables	500	19	0.7	80
	Art rooms	500	19	0.6	80
	Art rooms in art schools	750	19	0.7	90
	Technical drawing rooms	750	16	0.7	80
	Practical rooms and laboratories	500	19	0.6	80
	Handicraft rooms	500	19	0.6	80
	Teaching workshops	500	19	0.6	80
	Music practice rooms	300	19	0.6	80
	Computer practice rooms (menu driven)	300	19	0.6	80
	Language laboratories	300	19	0.6	80
	Preparation rooms and workshops	500	22	0.6	80
	Entrance halls	200	22	0.4	80
	Circulation areas, corridors	100	25	0.4	80
	Stairs	150	25	0.4	80
	Student common rooms and assembly halls	200	22	0.4	80
	Teachers rooms	300	19	0.6	80
	Library: bookshelves	200	19	0.6	80
	Library: reading areas	500	19	0.6	80
	Stock rooms for teaching materials	100	25	0.4	80
	Sports halls, gymnasiums, swimming pools (general use)	300	22	0.6	80
	School canteens	200	22	0.4	80
	Kitchens	500	22	0.6	80

### Health care premises

Rooms for general use	Waiting rooms	200	22	0.4	80
	Corridors: during the day	100	22	0.4	80
	Corridors: cleaning	100	22	0.4	80
	Corridors: during the night	50	22	0.4	80
	Multiple-use corridors	200	22	0.6	80
	Day rooms	200	22	0.6	80
	Elevators, lifts for passengers and visitors	100	22	0.6	80
	Service lifts	200	22	0.6	80

## Indoor workplaces

## Type of interior, task or activity

Health care premises		$\bar{E}_m$	UGR <sub>L</sub>	U <sub>0</sub>	R <sub>a</sub>
Staff rooms	Staff offices	500	19	0.6	80
	Staff rooms	300	19	0.6	80
Wards, maternity wards	General lighting	100	19	0.4	80
	Reading lighting	300	19	0.7	80
	Simple examinations	300	19	0.6	80
	Examination and treatment	1000	19	0.7	90
	Night lighting, observation lighting	5	-	-	80
	Bathrooms and toilets for patients	200	22	0.4	80
Examination rooms (general)	General lighting	500	19	0.6	90
	Examination and treatment	1000	19	0.7	90
Eye examination rooms	General lighting	500	19	0.6	90
	Examination of the outer eye	1000	-	-	90
	Reading and colour vision tests with vision charts	500	16	0.7	90
Ear examination rooms	General lighting	500	19	0.6	90
	Ear examination	1000	-	-	90
Scanner rooms	General lighting	300	19	0.6	80
	Scanners with image enhancers and television systems	50	19	-	80
Delivery rooms	General lighting	300	19	0.6	80
	Examination and treatment	1000	19	0.7	80
Treatment rooms (general)	Dialysis	500	19	0.6	80
	Dermatology	500	19	0.6	90
	Endoscopy rooms	300	19	0.6	80
	Plaster rooms	500	19	0.6	80
	Medical baths	300	19	0.6	80
	Massage and radiotherapy	300	19	0.6	80
Operating areas	Pre-op and recovery rooms	500	19	0.6	90
	Operating theatres	1000	19	0.6	90
	Operating cavity	-	-	-	-
Intensive care units	General lighting	100	19	0.6	90
	Simple examinations	300	19	0.6	90
	Examination and treatment	1000	19	0.7	90
	Night watch	20	19	-	90
Dentists	General lighting	500	19	0.6	90
	At the patient	1000	-	0.7	90
	Operating cavity	-	-	-	-
	White teeth matching	-	-	-	-

## Type of interior, task or activity

Health care premises		$\bar{E}_m$	UGR <sub>L</sub>	U <sub>O</sub>	R <sub>a</sub>
Laboratories and pharmacies	General lighting	500	19	0.6	80
	Colour inspection	1000	19	0.7	90
Decontamination rooms	Sterilisation rooms	300	22	0.6	80
	Disinfection rooms	300	22	0.6	80
Autopsy rooms and mortuaries	General lighting	500	19	0.6	90
	Autopsy tables and dissecting tables	5000	-	-	90
<b>Transportational areas</b>					
Airports	Arrival and departure halls, baggage claim areas	200	22	0.4	80
	Connecting areas, escalators, travelators	150	22	0.4	80
	Information desks, check-in desks	500	19	0.7	80
	Customs and passport control desks	500	19	0.7	80
	Waiting areas	200	22	0.4	80
	Luggage store rooms	200	25	0.4	80
	Security check areas	300	19	0.6	80
	Air traffic control towers	500	16	0.6	80
	Testing and repair hangars	500	22	0.6	80
	Engine test areas	500	22	0.6	80
	Measuring areas in hangars	500	22	0.6	80
Railway installations	Covered platforms and passenger subways (underpasses)	100	-	0.4	40
	Fully enclosed platforms, large number of persons	200	-	0.5	60
	Pedestrian underpasses, small number of persons	50	28	0.5	40
	Pedestrian underpasses, large number of persons	100	28	0.5	40
	Ticket halls and concourses	200	28	0.5	40
	Ticket and luggage offices and counters	300	19	0.5	80
	Waiting rooms	200	22	0.4	80
	Entrance halls, station halls	200	-	0.4	80
	Signal boxes, technical rooms	200	28	0.4	60
	Access tunnels	50	-	0.4	20
	Maintenance and repair bays	300	22	0.5	60

## Indoor workplaces

### Type of interior, task or activity

The following details apply to competition class I (lower requirements apply to classes II and III)

$\bar{E}_m$  and  $R_a$  data according to European Standard EN 12193

General school sports data from EN 12464

An  $R_a$  level of 80 should be preferred

For lighting for training purposes, usually an  $UGR_L$  level of 22 should be observed

#### Sports facilities

	$\bar{E}_m$	$R_a$
Aerobics	500	60
Archery	200	60
Athletics (all disciplines)	500	60
Badminton	750	60
Basketball	750	60
Billiards	750	80
Boccia	300	60
Boules	300	60
Bowling	200	60
Bowls	500	60
Boxing (competition/training)	2000/300	80
Climbing	500	60
Cricket	750	60
Cricket nets	1500	60
Curling (target/playing areas)	300/200	60
Cycling	750	60
Dancing (fitness)	500	60
Darts	200	60
Fencing	750	60
Figure skating	750	60
Fistball	750	60
Floorball	750	60
Football (indoor)	750	60
Gymnastics	500	60
Gymnastics (floor exercises, apparatus work)	500	60
Handball	750	60
Hockey	750	60
Ice hockey	750	60
Ice speed skating (400 m and skating rink)	500	60
Judo	750	60
Kendo/Karate	750	60
Netball	750	60
Ninepins	200	60

## Type of interior, task or activity

### Sports facilities

	$E_m$	$R_a$
Petanque	300	60
Racketball	750	60
Riding	500	60
Roller skating	500	60
Shooting	200	60
School sports	750	60
School sports (general use)	300	80
Snooker	750	80
Squash	750	60
Swimming	500	60
Swimming (school level)	300	80
Table tennis	750	60
Tennis	750	60
Volleyball	750	60
Weight lifting	750	60
Wrestling	750	60

## Outdoor workplaces

### Type of outdoor workplace, task or activity

#### General circulation areas at outdoor workplaces

	$E_m$	$R_a$
Walkways exclusively for pedestrians	5	20
Traffic areas for slowly moving vehicles max. (10 km/h), e.g. bicycles, trucks and excavators	10	20
Regular vehicle traffic (max. 40 km/h)	20	20
Pedestrian passages, vehicle turning, loading and unloading points	50	20

#### Airports

Hangar aprons	20	20
Terminal aprons	30	40
Loading areas	50	40
Fuel depots	50	40
Aircraft maintenance stands	200	60

#### Building sites

Clearance, excavation and loading	20	20
Construction areas, drain pipes mounting, transport, auxiliary and storage tasks	50	20
Framework element mounting, light reinforcement work, wooden mould and framework mounting, electric piping and cabling	100	40
Element jointing, demanding electrical, machine and pipe mountings	200	40

#### Fuel filling stations

Vehicle parking and storage areas	5	20
Entry and exit driveways: dark environment (i.e. rural areas and suburbs)	20	20
Entry and exit driveways: light environment (i.e. cities)	50	20
Air pressure and water checking points and other service areas	150	20
Meter reading areas	150	20

#### Industrial sites and storage areas

Short term handling of large units and raw materials, loading and unloading of solid bulk goods	20	20
Continuous handling of large units and raw materials, loading and unloading of freight, lifting and descending location for cranes, open loading platforms	50	20
Reading of addresses, covered loading platforms, use of tools, ordinary reinforcement and casting tasks in concrete plants	100	20
Demanding electrical, machine and piping installations, inspection	200	60

## Type of outdoor workplace, task or activity

### Offshore facilities for gas and oil extraction

	$\dot{E}_m$	$R_a$
Sea surface below the platform	30	20
Ladders, stairs, walkways	100	20
Boat landing areas, transport areas	100	20
Helicopter landing areas	100	20
Drill towers	100	40
Processing areas	100	40
Piping depot/deck	150	40
Test stations, shakers, drillheads	200	40
Pump areas	200	20
Lifeboat areas	200	20
Drill floors, drill surfaces, platforms at drill tower	300	40
Sludge chambers, sampling	300	40
Crude oil pumps	300	40
Facility areas	300	40
Rotary tables	500	40

### Parking areas

Light traffic, e.g. parking areas of shops, terraced and apartment houses; cycle parks	5	20
Medium traffic, e.g. parking areas of department stores, office buildings, plants, sports and multipurpose building complexes	10	20
Heavy traffic, e.g. parking areas of schools, churches, major shopping centres, major sports and multipurpose building complexes	20	20

### Petrochemical and other hazardous industries

Handling of servicing tools, utilisation of manually regulated valves, starting and stopping motors, lighting of burners	20	20
Filling and emptying of container trucks and wagons with risk free substances, inspection of leakage, piping and packing	50	20
Filling and emptying of container trucks and wagons with dangerous substances, replacements of pump packing, general service work, reading of instruments	100	40
Fuel loading and unloading sites	100	20
Repair of machines and electric devices	200	60

### Power, electricity, gas and heat plants

Pedestrian movements within electrically safe areas	5	20
Handling of servicing tools, coal	20	20
Overall inspection	50	20
General servicing work and reading of instruments	100	40
Wind tunnels: servicing and maintenance	100	40
Repair of electric devices	200	60

## Outdoor workplaces

### Type of outdoor workplace, task or activity

#### Railways and tramways

Railway areas including light railways, tramways, monorails, miniature rails, metro, etc.

	$E_m$	$R_a$
Tracks in passenger station areas, including stabling	10	20
Railway yards: flat marshalling, retarder and classification yards	10	20
Hump areas	10	20
Freight track, short duration operations	10	20
Open platforms, rural and local trains, small number of passengers	15	20
Walkways	20	20
Level crossings	20	20
Open platforms, suburban and regional trains with large number of passengers or inter-city services with small number of passengers	20	20
Freight track, continuous operation	20	20
Open platforms in freight areas	20	20
Servicing trains and locomotives	20	40
Railway yards handling areas	30	20
Coupling areas	30	20
Stairs, small and medium-size stations	50	40
Open platforms, inter-city services	50	20
Covered platforms, suburban or regional trains or inter-city services with small number of passengers	50	40
Covered platforms in freight areas, short duration operations	50	20
Covered platforms, inter-city services	100	40
Stairs, large stations	100	40
Covered platforms in freight areas, continuous operation	100	40
Inspection pit	100	40

#### Saw mills

Timber handling on land and in water, sawdust and chip conveyors	20	20
Sorting of timber on land or in water, timber unloading points and sawn timber loading points, mechanical lifting to timber conveyor, stacking	50	20
Reading of addresses and markings of sawn timber	100	40
Grading and packaging	200	40
Feeding into stripping and chopping machines	300	40



**Extracts from:**

ÖNORM [Austrian standard] EN 12464-1  
Light and lighting – Lighting of workplaces – Part 1:  
indoor workplaces (2011-07-01)

ÖNORM EN 12464 Part -2,  
Light and lighting – Lighting of workplaces – Part 2:  
outdoor workplaces (2007-10-01)

ÖNORM EN 1246412193  
Light and lighting – Sports facility lighting (2008-04-01)

Published with permission by the Austrian Standards Institute,  
A-1020 Vienna, Heinestrasse 38  
For ordering standards and products or research on the subject,  
please go to [www.on-norm.at](http://www.on-norm.at)

Pay attention to the EN 13201 series of standards for  
street lighting.



## Lighting application

---

### Active Light | Connecting with Nature

Creating Light creates Life	48
Active Light in connection with art and nature	50

---

### Application areas

Light for Offices and Communication	52
Light for Education and Science	54
Light for Presentation and Retail	56
Light for Hotel and Wellness	58
Light for Art and Culture	60
Light for Health and Care	62
Light for Industry and Engineering	64
Light for Outdoor and Architecture	66
Light for Living	68

---

## Active Light | Connecting with Nature

### Creating Light creates Life

Always reliable yet simultaneously surprising, natural light has guided and accompanied us since the dawn of time. It is intuitive to our needs and caters to our natural rhythm. It has a dynamic influence on our sight, thus blessing us with new images every day that set our emotions free. It controls human processes and influences our internal clock.

Active Light emulates natural light in a unique way, which, when unified with architecture, opens the realms of time and space to various ambiances of human interaction.

Consequently, an exploration in light flow, intensity, color and focus points are created to achieve what natural light can: evoking emotion through light.

01:00

02:00

03:00

04:00

05:00

06:00

07:00

08:00

09:00

10:00

11:00

12:00



**Active Light – Connecting with Nature**

## Active Light in connection with art and nature

**The four dimensions of light**

Only through light can art truly become an experience. The perfect presentation of paintings, photographs, sculptures and archaeological artefacts requires a deep understanding of the respective space, the medium and the curatorial theme. Effective lighting concepts follow the planning principles of museum lighting. A successful lighting design will encompass the four dimensions of light – direction, illuminance, colour and time – to create a fascinating single entity.





## Application areas

### Light for Offices and Communication



#### Working and feeling at ease

Making work easier	<ul style="list-style-type: none"> <li>- Complying with standards (adjusting illuminance levels to tasks)</li> <li>- Avoiding glare by light</li> </ul>
Creating an identity	<ul style="list-style-type: none"> <li>- Lighting design in the overall architectural context</li> <li>- Taking CI into account</li> </ul>
Promoting health	<ul style="list-style-type: none"> <li>- Adjusting biologically effective light to the circadian day/night rhythm</li> <li>- Daylight as preferred source of light</li> <li>- Artificial lighting using Tunable White</li> </ul>
Employees as a cost factor	<ul style="list-style-type: none"> <li>- Staff cost analysis in comparison with investment and operating costs</li> <li>- Result: lighting solutions must be subject to people's demands</li> <li>- Light enhances people's performance and creativity</li> </ul>

#### Technology and flexibility

Creating different zones	<ul style="list-style-type: none"> <li>- Structuring and orientation in space through lighting design for vertical surfaces, transit areas, pools of light etc.</li> <li>- Arranging groups using lighting management</li> </ul>
Bolstering activity	<ul style="list-style-type: none"> <li>- Adjustment through lighting management</li> <li>- Taking into account changing work media (such as tablets): no high luminance levels at steep angles</li> </ul>
Preserving individuality	<ul style="list-style-type: none"> <li>- Keeping demographic trends in mind</li> <li>- Lighting management for individual control options</li> </ul>
Being flexible	<ul style="list-style-type: none"> <li>- Glare limitation at all angles for flexible utilisation of space</li> <li>- Lighting management: free-standing luminaire concepts and re-grouping of ceiling solutions</li> </ul>



## Effectiveness and efficiency

Sustainability	<ul style="list-style-type: none"> <li>- Increases the value of buildings</li> <li>- Lighting management: daylight-based control or presence-based control</li> <li>- Efficient luminaires, lighting concepts</li> </ul>
Integral approach	<ul style="list-style-type: none"> <li>- All visual tasks and zones of the building</li> <li>- Integrating the lighting management system into higher-level building services</li> </ul>
Rational refurbishment	<ul style="list-style-type: none"> <li>- Short payback periods of new technologies</li> <li>- Wireless control technology</li> </ul>
Added value thanks to LEDs	<ul style="list-style-type: none"> <li>- Perfect integration into lighting management system</li> <li>- Unaffected by frequent switching and dimming</li> <li>- Life-cycle assessment shows benefits: reduced energy consumption, long service life, low maintenance effort</li> </ul>

## Customer benefits of lighting management and Active Light

The requirements on lighting change over time, and with the place, the person and work they have to do. A lighting management system is based on actual needs and provides the optimum light.

Concentrated work and increasing communication place changing demands on the lighting situation. Additional, biologically effective components of artificial lighting that complement daylight at appropriate times of day work in harmony with our internal body clock and are invigorating.

Using time-based management, daylight-based control and presence-based control, the system achieves a high level of automation. This is associated with maximum energy savings and flexibility for adjustments.

Where staff members can individually control the lighting situation in their work environment, the technology is accepted most easily. This requires sufficient control options and small groups of luminaires with appropriately allocated responsibilities.

## Application areas

### Light for Education and Science



#### Environmental aspects

Use of daylight	– Energy efficiency through lighting management
Efficient luminaires and intelligent control	– LED solutions are highly efficient – Frequent dimming and switching does not affect the LEDs' service life

#### Ergonomic compatibility

Performance and concentration	– Standards cover basic visual requirements such as glare or illuminance – Emotional components enhance concentration – Open room ambience thanks to brightening up of ceiling and walls
Feeling at ease and health	– Feeling at ease enhances people's performance – Light stabilises the inner biological clock, measurably stimulates hormonal processes – Medical evidence shows that light enhances cognitive performance
Adjusting light to activities and visual tasks	– Blackboard lighting: high visual demands because of accommodation required from the eye for close and distant vision when reading and copying from the blackboard – Teamwork

### New teaching methods

- |                            |  |
|----------------------------|--|
| Mobility and communication | <ul style="list-style-type: none"> <li>- Flexible seating arrangement</li> <li>- More teamwork and communication</li> <li>- Face recognition requires well-balanced direct/indirect components</li> <li>- Quickly retrievable, flexible luminaire grouping and scenes</li> <li>- Presence-based control in case of extensive periods of use (such as corridor zones at universities in the evening)</li> </ul> |
|----------------------------|--|

- |   |   |
|---|---|
| New learning methods and teaching materials | <ul style="list-style-type: none"> <li>- Increasingly screen-based work, also on tablets: glare control at flat and steep angles</li> </ul> |
|---|---|

### New technologies

- |                         |   |
|-------------------------|---|
| Variety and flexibility | <ul style="list-style-type: none"> <li>- Lighting management: flexible use of rooms, dynamically changing light (daylight and artificial lighting) creates variety</li> </ul> |
|-------------------------|---|

- |  |   |
|--|---|
| Lighting scenes at the touch of a button | <ul style="list-style-type: none"> <li>- Clearly laid out control units with selection of scenes</li> </ul> |
|--|---|

## Customer benefits of lighting management and Active Light

New teaching methods and media technologies require flexible room usage and frequent adjustment of lighting situations. These can be implemented by the press of a button using intuitive control units with predefined scenes – for working in small groups or teacher-centred teaching, a reduced level for data projector presentations or higher vertical illuminance levels for blackboard and flip charts.

Daylight is stimulating and enhances people's sense of well-being and performance. Using daylight-based control and presence-based control, maximum energy savings are achieved – without any compromises in terms of lighting quality.

Blinds control enhances the contrasts for presentation media and additionally increases room comfort, since glare and thermal output are minimised.

## Application areas

### Light for Presentation and Retail



#### Setting the scene

##### Limbic Lighting

- Target group-specific lighting solutions that affect the emotional conditions of the customer groups
- Increase turnover by taking into account specific customer needs at the POS

##### Stimulating desires

- Guiding perception: direction of light, luminance levels and light colours rich in contrast matched to the goods on display

##### Brand communication

- Emotional lighting design through illumination of façades and shop windows

#### Authenticity

##### Creating accents

- High-precision accent lighting
- Excellent colour rendering: brilliance and authenticity

##### Directing the gaze

- Long-distance effect, orientation and enhanced room depth perception thanks to illuminated peripheral areas, vertical surfaces and shelf rear walls

##### Reducing lighting distances

- Presenting objects in greater detail
- Miniaturised lighting systems focus people's attention on the goods displayed

##### Modelling objects

- Diffuse light to lend sleek lines to highly reflective objects
- Presenting objects authentically with a three-dimensional effect: interplay of diffuse and directed light

### Naturalness

Emphasising freshness	<ul style="list-style-type: none"> <li>- LED solutions with high colour rendering and matching colour temperature</li> <li>- Gentle illumination of fresh goods to boost sales</li> </ul>
Adjusting colour temperature	<ul style="list-style-type: none"> <li>- LED incorporating revolutionary Tunable Food and tunableWhite technology</li> <li>- Choice of various colour temperatures in one luminaire</li> <li>- Formerly: filters and lamps had to be changed</li> </ul>
Gentle illumination	<ul style="list-style-type: none"> <li>- LED is virtually free from IR and UV radiation</li> <li>- No filters or protective devices</li> </ul>

### Sustainability

Increasing efficiency	<ul style="list-style-type: none"> <li>- Linear LED solutions instead of fluorescent lamps</li> <li>- Vertical luminance levels prevail over horizontal lighting design</li> </ul>
Reducing energy consumption	<ul style="list-style-type: none"> <li>- LED combined with lighting management</li> <li>- Monitoring ancillary areas via presence detectors</li> </ul>
Replacing the lighting system	<ul style="list-style-type: none"> <li>- Comparing operating costs against investment costs</li> <li>- Increased lighting quality with higher efficiency possible (LED technology)</li> </ul>

## Customer benefits of lighting management and Active Light

Lighting scenes are adjusted to various activities using intuitive control points – from task lighting at the POS terminals to gentle colour changes required for the lounge.

Thanks to increasing energy awareness, more and more dimmable luminaires are used in retail spaces. Positive material effects of goods and architecture are leveraged by possible changes in colour temperature combined with luminance levels (tunableWhite).

Skilfully controlled lighting solutions are characterised by high levels of comfort and flexibility as well as low maintenance effort. For example, perfect adjustment of the

light spectrum to the illuminated object is achieved without complicated replacement of filters. Using adequate control points, time-lines or daylight-based control, ambient lighting is gently modified. The use of daylight not only helps to save energy, but makes room zones appear especially attractive.

Highly emotional illumination of goods and surprise effects can be achieved using static and dynamic lighting scenes.

Active Light solutions on the basis of Limbic Lighting knowledge allow a dynamic adaptation to the personality-based needs of various target groups.

## Application areas

### Light for Hotel and Wellness



#### New technologies

- |            |   |
|------------|---|
| Networking | <ul style="list-style-type: none"> <li>- Lighting management system</li> <li>- Lighting scenes: multi-functional use of seminar rooms and conference halls</li> </ul> |
|------------|---|

- |                         |   |
|-------------------------|---|
| Flexible use of screens | <ul style="list-style-type: none"> <li>- Glare control at steep angles for smartphones and tablets</li> </ul> |
|-------------------------|---|

#### Exacting design aspirations

- |                        |   |
|------------------------|---|
| Enhancing architecture | <ul style="list-style-type: none"> <li>- Illumination of façade and entrance area</li> <li>- Choice of luminaires reflecting the hotel's design language</li> </ul> |
|------------------------|---|

- |                       |  |
|-----------------------|--|
| Decorative luminaires | <ul style="list-style-type: none"> <li>- New designs thanks to LED technology</li> </ul> |
|-----------------------|--|

- |                          |  |
|--------------------------|--|
| Attractive control units | <ul style="list-style-type: none"> <li>- Specially designed control units with intuitive lighting scenes and pictographs for hotels</li> </ul> |
|--------------------------|--|

#### Globalisation

- |                    |  |
|--------------------|--|
| Variety of options | <ul style="list-style-type: none"> <li>- Extensive product portfolio</li> <li>- Taking regional influences into account</li> </ul> |
|--------------------|--|

- |   |   |
|---|---|
| Service on site and multi-cultural competence | <ul style="list-style-type: none"> <li>- Global planning</li> <li>- Transnational distribution network</li> <li>- Regional adaptation</li> <li>- Knowledge of national regulations</li> </ul> |
|---|---|

## Responsibility

Sustainable products	- Environmentally certified luminaires
Efficient luminaires and optimised lighting management	- Sufficient control options and central "off" of the entire unit next to the room door
Safety and security	- Integration of emergency lighting - Orientation in corridors and car parks

## Spa and wellness

Enhancing health and well-being, relaxation	- Gentle and dynamic changes in light colour - Creating specific pools of light and dark zones in the spa area
---	---

## Customer benefits of lighting management and Active Light

When it comes to hotel rooms, the guest's individual wishes have top priority. In terms of lighting, intuitive control units allow to create personal settings: using blinds control, artificial lighting and daylight can be conveniently adjusted to a variety of room requirements and visual demands – depending on whether the guest wants to watch TV, put on make-up or read.

Dynamic lighting scenes, flexibly defined via timelines or controlled according to weather situation and time of day, have an

influence on the guests' well-being – mainly in restaurants and wellness areas. Moreover, they optimise the adaptation conditions for the eye when entering the building, depending on the lighting situation outdoors, which provides security and orientation.

Predefined lighting scenes in conference areas allow for multiple changes in media, providing the right light at the press of a button. Integration of emergency lighting into the higher-level lighting management system allows central monitoring of the system.

## Application areas

### Light for Art and Culture



#### Perfectly staged

Four dimensions of light	- Experience art with Active Light that controls and compares the light direction, luminous intensity, light colour and time
Art and architecture	- Architectural and artistic confrontation to enhance the experience of art

#### Lighting tools for a variety of planning approaches

Art-centred highlighting	- Extensive portfolio for planning lighting, from Superspot to Wallwasher - Curatorial freedom through a variety of accessories along with maximum flexibility and precision
tunableWhite	- Adjust the light colour in the context of the history of the work of art (candlelight, daylight) → curatorial context - Change the light colour in the general lighting according to the expectations of people and in the natural course of the day → architectural context



### Conservation goals

Gentle LED technology	- Marginal IR and UV load thanks to an LED product portfolio
Lighting management and tunableWhite	- tunableWhite and lighting control to reduce potential damage through shorter radiation times and the use of gentle wavelengths
Scientific support and advice	- Service through on-site measurements and advice based on scientific knowledge

### Energy and maintenance

Energy costs	- Short payback times through the use of new LED technology with a lower energy consumption - Dimmable luminaires are more gentle and optimise the energy balance
Maintenance costs	- Long service life of LED luminaires minimise the maintenance costs - 5 year warranty

## Customer benefits of lighting management and Active Light

A lighting management system makes sure that exhibits which are sensitive to light are exposed only to the amount of light that is absolutely necessary: exactly that luminance level or light colour (tunableWhite) that are required for good perception. Thanks to presence-based control, illumination is restricted to the time when visitors are present.

Times for switching on and off can be specified for particular times of day. Blinds

management and daylight sensors allow just the amount of daylight that is absolutely necessary – as a balance between architecture, human well-being, gentle illumination of exhibits and energy costs.

Unobtrusively and with central monitoring, the emergency lighting system is integrated into the lighting management system, ensuring reliable visual conditions in an emergency.

## Application areas

### Light for Health and Care



#### Health and activity

Quality for patients and persons in need of care

- Taking into account dementia patients
- Avoiding mirror effects and reflections (delusions)

Feeling at ease and supporting the inner clock

- In many healthcare facilities, no daylight – an important means of stabilising the inner clock – is available
- Little time is spent outdoors
- Compensation by artificial lighting: well-adjusted changes in light colours and illuminance levels
- High intensity in pools of light

Enhancing comfort and providing security

- Bedside lighting
- Age-appropriate lighting scene concept in line with healthcare requirements

#### Reliability and functionality

Visual comfort and security for patients and residents

- Emergency lighting
- Providing orientation
- Avoiding heavy shadows and dark zones
- Pleasant corridor design using indirect light components on ceiling and walls

Supporting diagnosis and treatment

- Increase in illuminance levels: at the press of a button at the patient's bedside or via additional light components
- High colour rendering index

Optimising doctors' and nurses' working conditions

- Individual settings, intuitive operation
- Special illumination to meet high demands (operating theatres and intensive-care units)
- Where people work at night: support the circadian rhythm with biologically effective lighting

Flexibility

- Modular lighting design so that the light can easily be adjusted to the way the room is used

### Eco-friendly and economically efficient

Added value for operators and investors	- Daylight-based control and lighting scenes that can be called up individually enhance comfort and increase efficiency
Optimising energy consumption	- Efficient luminaires and light sources - Corridor lighting with presence-based control and LED – unaffected by frequent switching and dimming
Enhancing the health and care facility's image	- High-quality appearance of façade, parking spaces, entrance and waiting areas
Integral approach	- Central lighting control system with monitoring, including the emergency lighting system

### Customer benefits of lighting management and Active Light

Successful lighting solutions in residential care homes and hospitals offer intuitive age-appropriate control options that are also suitable for use by disabled persons. Using a lighting management system, a variety of lighting scenes required for residential and nursing purposes can be called up at the press of a button.

Due to age-related changes in the eye, the demand for light increases with age. For more sophisticated visual tasks, the artificial lighting can be individually adjusted by nursing staff and patients. As a result of

processes of degradation in the eye, biologically highly effective bluish components are filtered out. The inner clock and the associated sleeping and resting patterns must therefore be supported by spending time outdoors or by biologically effective artificial lighting with high intensity levels or with a large bluish component at defined times of the day.

Timelines defined within the scope of the lighting management system make the interplay of artificial lighting and daylight perfect at any time of day.

## Application areas

### Light for Industry and Engineering



#### Efficiency

Reducing energy consumption and CO<sub>2</sub> emissions

- Up to 24 working hours, often with little daylight, require highly efficient technologies
- Primarily use of daylight, also to enhance well-being
- Presence-based monitoring of ancillary or less frequented areas
- Positioning companies as environmentally committed by obtaining certificates

Facilitating maintenance and replacing the lighting system

- Large-scale room dimensions result in high maintenance effort
- Reduced effort thanks to durable and efficient LED solutions and lighting management systems

#### Adaptability

Variety of options for rooms with high ceilings

- Uniform general lighting using linear fluorescent lamps or LEDs for typical room heights
- Illumination of high bays: pinpointed high-pressure discharge lamps require compromises because of poor integration into the lighting management system (ignition and dimming behaviour)

Integral design using lighting management throughout the whole building

- Lighting solution on a one-stop basis, from the car park to workstations to storage facilities
- Variable production facilities require flexibility, quick adaptation of luminaires or luminaire groups

Transparency and image

- More open architecture for creating brand identity
- Clear arrangement of luminaires, in compliance with architectural zones, important for night-time effect
- Façade lighting

## Productivity

- |                                       |  |
|---------------------------------------|--|
| Empowerment and increased performance | <ul style="list-style-type: none"> <li>- Taking into account not only the workstation, but also well-balanced luminance distribution in the room</li> <li>- Focussing the lighting design on special requirements for individual task areas</li> <li>- Individual lighting control enhances well-being</li> <li>- Variable colour temperatures and luminous intensities provide optimum support for people working shifts</li> </ul> |
|---------------------------------------|--|
- 

## Reliability

- |                          |  |
|--------------------------|--|
| Resistant and tough      | <ul style="list-style-type: none"> <li>- The lighting is resistant to various environmental conditions: from extreme temperatures, water and vibrations, right through to various chemicals and vapours</li> </ul>   |
| Cleanliness and security | <ul style="list-style-type: none"> <li>- Low-maintenance luminaires that are easy to clean offer few surfaces on which dirt can settle</li> <li>- Materials resistant to cleaning agents and disinfectants</li> <li>- Explosion-proof luminaires</li> <li>- Sense of security: vertical luminance levels for opening up spaces</li> <li>- Special emphasis on dangerous zones</li> </ul> |
- 

## Customer benefits of lighting management and Active Light

Shift and night work as well as an absence of daylight mean that presence times for industrial lighting systems are greatly extended. This results in high energy saving potential.

Lighting management perfectly complies with the required flexibility in production facilities. As maintenance factors must be taken into account, the design of new systems requires over-dimensioning. Functions such as daylight-based control or Maintenance Control counteract this additional energy consumption by continuously adjust-

ing the lamp output depending on the daylight situation or service life.

Integral lighting solutions are created by close interlacing of the control system and the luminaire portfolio, as perfectly implemented in the TECTON continuous-row lighting system. Maintenance and monitoring are optimised in combination with integration of the emergency lighting system. In addition, interfaces with other building services ensure convenient and cost-efficient operation of buildings.

## Application areas

### Light for Outdoor and Architecture



#### Human experience

##### Social factors

- Give back an urban environment to people at night
- Encourage interaction
- Create interesting places that are just begging to be discovered
- Support human activities

##### Emotional factors

- Turn familiar streets into something new and unexpected
- Adapt the light to habits and needs

##### Perception-related factors

- Highlight urban details and give people the chance to experience their surroundings in a new way
- Improve the general perception, feeling of well-being and comfort of a location
- Orientation

#### Sustainability and sensibility

##### Ecological factors

- Lower the energy consumption with the help of high-quality light sources and optical systems
- Avoid light pollution: this means more than just pointing the light towards the ground. Rather, sensible design strategies are aimed at enhancing rooms and improving the three-dimensional perception.

##### Design factors

- To always illuminate places correctly and at the right time with adaptive systems, without wasting light
- Create a balance between artificial light and darkness (starting from the natural situation at night): This reduces the energy consumption in the system and improves the visual quality

## Adaptability and identity

Social identity factors	<ul style="list-style-type: none"> <li>- Improve the quality of life and unique experiences through local identity</li> <li>- Feel good during interactions: this encourages a sense of belonging to the place and community, thus creating a social identity</li> </ul>
Design factors	<ul style="list-style-type: none"> <li>- Help to change an empty space into living space</li> <li>- Create a non-static identity: light is based on how people use a certain room at certain times.</li> <li>- Create a lighting environment to make spaces more inviting</li> </ul>

## Multilayer design approach with Active Light

Layers of light	<ul style="list-style-type: none"> <li>- Individually define the way a room is experienced at night</li> <li>- Present the three-dimensional room precisely: subtle dynamics improve the human experience of certain places at certain times.</li> <li>- Various layers change in relation to the current activity (or time span)</li> </ul>
Toolbox of light	<ul style="list-style-type: none"> <li>- Choose from modular concepts: adapt light to the design requirements, but still ensure consistent design across projects and spaces</li> <li>- Combine precision with visual comfort through adjustable optics</li> <li>- "Composite Beam" concept</li> <li>- Simple and flexible installation, easy adjustment on site</li> <li>- Choose a uniform and integrated design language for the entire room</li> <li>- Future-safe control and integration in further systems</li> </ul>

## Customer benefits of lighting management and Active Light

Intelligent systems are becoming increasingly important in outdoor areas too and represent an important step towards achieving sustainable goals. In the context of a human and sociocentric approach, it can be understood as part of a complete design process. Semi-autonomous systems are hereby controlled on the basis of human behaviour (presence detection), their activities and emotions (changing colour temperature) and the times of the day.

The Zumtobel outdoor portfolio covers intelligent DMX or DALI devices that allow greater flexibility to control every single luminaire.

According to our application approach, we offer adaptive lighting solutions that allow light segmentation for individual luminaires using multi-channel devices. This method opens the door to lighting design where the luminaires can fulfil various design tasks from a single position.

## Application areas

### Light for Living



#### We improve the quality and effect of light in private domestic and living space

- Thanks to our unique network of architects and planners, our application knowledge and the latest LED and control technology

#### We cut installation and operating costs

- Through our profound understanding of users' needs, smart, sustainable lighting solutions and professional support in all phases of a project

#### We encourage well-being and health

- Through bioactive lighting systems and settings, developed on the basis of continuous research.

### Customer benefits of lighting management and Active Light

Scenes can be comfortably recalled at the press of a button with the control units. The mood in a room can be changed completely by defined static or dynamic lighting scenes. For example, a kitchen-cum-living room with a high luminous intensity and light with few shadows can be optimised for the needs of work in the kitchen. It later becomes the central communication point to welcome guests with a glass of champagne in cosy reddish, dimmed light.

The living area can also have a supportive biological effect on health. Dynamic light scenes are defined to create a natural and healthy transition to relaxing sleep in the evening with a reduced, reddish light. In the morning, the special sense cells on the retina are activated to the highest intensity through a higher share of bluish light.



# Technology

---

## Key parameters in the lighting catalogue

Data sheet 70

---

## LED technology

Functions and types of LEDs 72

LED features 72

Important LED key figures 73

Technology used in Zumtobel's LED modules 76

---

## Light control technology

Optics 78

Technology and application in products 80

---

## Key parameters in the lighting catalogue

The **data sheet** provided for each luminaire in the electronic catalogue contains key data for correct planning with Zumtobel luminaires.

- 1) Luminaire name and article number
- 2) Text for call for tenders
- 3) Photo and dimensions
- 4) Light distribution

(LID: Luminous Intensity Distribution)

- The luminous intensities are shown in the unit cd/klm (1 klm = 1000 lm). The operating efficiency of the luminaries  $\eta$  is taken into account in the LID. In order to determine the absolute luminous intensities, reference is made to the luminaire's light output for LED luminaires and to the lamp's light output for luminaires with conventional light sources.
- The operating efficiency of  $\eta$  LED luminaires is set to 100% since the efficiency is already taken into account in the luminaire's light output.

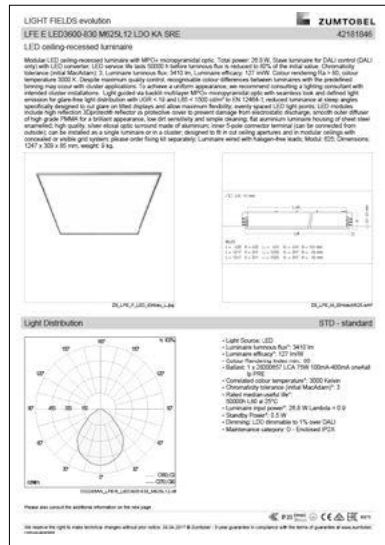

All of the terminology used and basic technical calculation methods correspond to the recommendations of the guideline "Planning reliability in LED lighting" of the ZVEI (2nd edition; last revised: March 2016).

### 5) Key parameters:

Light source	Type and name
Luminaire's light output*: [lm]	[lm]
Luminaire's luminous efficacy*: [lm/W]	[lm/W]
Min. colour rendering index: $R_a$ or CRI	$R_a$ or CRI
Control gear:	[designation]
Correlated colour temperature*: [K in Kelvin]	[K in Kelvin]
Colour coordinates tolerance (initial MacAdam)*: Levels of ellipses	Levels of ellipses
Mean rated lamp life*: e.g. 50 000 h L80 at 25°C	e.g. 50 000 h L80 at 25°C
Luminaire output*: [W] input power, tw. with $\lambda = 0.9$	[W] input power, tw. with $\lambda = 0.9$
Standby power*: [W]	[W]
Control:	Details of trigger device
Maintenance category:	Type of maintenance, see chapter 8

All values marked \* are rated values

The parameters are described in more detail in the section on "LED Technology" (see page 72).

The permissible operating temperatures are shown in some cases, whereby the light output, power consumption, colour temperature and lamp life can vary by up to 10% within the named range.

More details of the luminaires can be found in the electronic catalogue

### Colour code

The colour code is a three-digit numerical value (e.g. 840) that describes the lighting quality of a white light source. The first digit denotes colour rendering, the second and third digits denote colour temperature (light colour).

Example:

840 → 8xx colour rendering index > 80  
→ x40 colour temperature 4000 K



### Risk groups

In principle, all light sources have to be tested with respect to their possible harmful effect for human eyes (EN 60598-1 [2015], EN 62471 Photobiological safety of lamps and lamp systems). Their safety is confirmed by the CE symbol. Damage to the retina by optical radiation hereby depends on:

- the spectral shares
- the radiation strength
- how long the person looks into the light source

Light sources are classified in *risk groups (RG)*:

- RG 0: No general risk
- RG 1: No risk with normal use
- RG 2: No risk with natural aversion reactions
- RG 3: Risk with even a fleeting glance

If it is dangerous to “stare” into a light source for a longer period of time, RG 2 has to be marked with the following symbol:



Symbol: Do not stare into light source/luminaire!

Source: © VDE

Zumtobel luminaires do not in principle constitute a danger for human eyes. All of our luminaires fall under RG 0 or 1, so that they do not have to be marked.

### Maintenance and dismantling

Notes on maintenance and dismantling as required by EU Directive 245/2009 can be found as a download in the electronic catalogue.

### Guarantee and warranty

Notes on the warranty terms can be found in the electronic catalogue under “5-year warranty”.

## LED technology

### Functions and types of LEDs

An LED (light-emitting diode) is an electronic semiconductor component that emits light when a current flows through it. The wavelength of the light depends on the semiconductor material and its doping. The spectrum of LEDs offers a major benefit: only light (electromagnetic radiation in the visible range) and no ultraviolet or infrared radiation is emitted.

#### **Basically, there are three types of LED:**

- Standard through-hole LED: often used as indicator light source, although with low light output. Due to their shorter service life, higher probability of failure and sensitivity to UV radiation, they are not used in lighting technology.
- SMD (surface mounted device) LED: an LED that is reflow-soldered to the surface of a printed circuit board (using a reflow oven). Basically, it consists of an LED chip protected by silicon coating mounted in or on a housing or a ceramic plate with contacts.
- CoB (chip on board) LED: the LED chip is mounted directly on the printed circuit board. This allows a dense arrangement of chips close to each other.

### LED features

- High efficiency = high luminous efficacy (lumen/watt)
- Long service life
- Broad spectrum of white light (warm white to daylight white)
- No UV or infrared radiation
- Compact size
- Good to excellent colour rendering index ( $R_a$ )
- Luminous flux and service life highly temperature-sensitive
- No environmentally harmful materials (e.g. mercury)
- Resistant to vibrations and impact
- Saturated colours
- Immediate start, i.e. 100% luminous flux after switching on
- No ignition, boosting or cooling time
- High-precision digital dimming
- No shifting of colour locations during dimming
- Luminous flux and service life greatly dependent on temperature (increase at lower temperatures)

## Important LED key figures

### **Light output, output and luminous efficacy**

The light output, output and luminous efficacy are important key parameters to describe the efficiency of LED luminaires. The luminaire manufacturer has to specify these parameters for all of their luminaires. This information contains the losses in the light-deflecting and light-shielding components of the luminaire and thus the effect of the operating efficiency of the luminaire. The operating efficiency is not normally shown separately for LED -luminaires.

ATTENTION: The light output and luminous efficacy for built-in LED modules are higher than those of the luminaires, so that these cannot be compared with each other.

The values are quoted as rated values. This takes into account the fact that minor fluctuations may occur between the individual measured values during the production period of luminaire type as a consequence of production conditions. Unless otherwise specified, the values apply for an ambient temperature of 25 °C.

### **Rated light output of LED luminaires**

Initial illuminance at the start of operation (lm). The maximum deviation may be -10% (tolerance).

### **Rated output of LED luminaires**

Initial input power of a luminaire (W). The maximum deviation may be +10% (tolerance).

### **Luminous efficacy of LED luminaires**

Initial value for the ratio of light output to input power (lm/W).

### **Constant light output**

If constant light output technology is used, the light output of a luminaire remains constant over the lamp life. The measured output rises to the maximum value relative to the reduction in light output of the LED type used. This maximum input power corresponds to the initial value with a maximum light output.

Note: CLO: constant light output.

## LED technology

### Service life data for LEDs

The service life describes the time until the mean light output of an LED luminaire has dropped to a specified percentage of the initial light output.

Example: Service life “L80 50,000 h” means that the light output has dropped to 80 % of the initial value after 50,000 h operating time.

It is common to quote the “mean rated service life”.

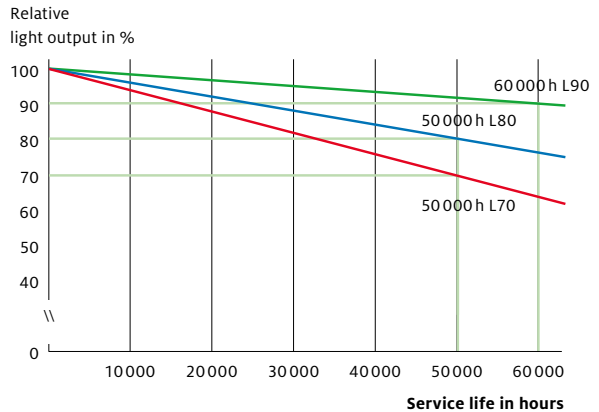

A service life of 50,000 h corresponds to continuous operation for around 5.7 years. When quoting longer service lives, it has to be considered which operating times would be necessary for these. With the normal operating times in office use of 2,500 h per year, a service life of 50,000 h corresponds to a presence time of 20 years.

Apart from the mean service life, the total failure rate AFV (Abrupt Failure Value) can also be quoted. This refers to the total failure of the modules in the luminaire and is normally less than 3%.

A failure of the control gear is excluded here. This has to be quoted separately and is normally covered by the warranty terms for the control gear.

Note to B10 and B50:

By values are statistical values: they mean that y percent of the product-based criteria are not fulfilled. However, a method exists

that allows such statistics to be safely calculated in advance for a longer operating time.

B50 identifies an approximate mean value for the reduction in luminous flux. B10 names 10% off luminaires that do not satisfy one criterion. This leads to the false assumption that B10 luminaires last longer than B50 luminaires.

What is correct is that service lives as long as these cannot be measured but only calculated. Whereas B50 can be derived from known forecasting methods, there is no method for B10 that is described in technical instructions. For this reason, those service life figures not further specified on a Zumtobel data sheet relate to B50. B10 has only become established for street lighting.

A maintenance factor can be determined for different presence times for various types of LED luminaires with a service life specification (see chapter 8).

## White light quality and binning

In the production of LED chips, LEDs of different production batches have different properties with respect to intensity, colour temperature, colour location, or with respect to forward voltage.

The properties of each individual LED are measured after manufacturing and allocated to a group showing the same features. These correspond to finely differentiated parameters which are divided into so-called bins. Depending on the application and the product, these features are weighted differently.

By using specific binning groups, colour and brightness tolerances – not just of the light emitted by individual luminaires, but also on visible luminous surfaces – are reduced to a minimum. Thus, illuminated surfaces and light emitting panels of luminaires are given a uniform appearance. This selection is especially important when it

comes to “single LED” products and applications with maximum white light quality such as museums.

In practice, MacAdam ellipses are often used to give users an idea of how far individual LED modules differ with respect to colour perception.

MacAdam ellipses describe the colour distances on the xy coordinates in the standardised colour table. In theory, we talk about 1 MacAdam as soon as there is a visual difference with respect to colour perception.

A colour difference between individual LED modules of one luminaire and between individual LEDs, i.e. individual luminaires in case of spotlights, of 2 MacAdam ellipses is at present considered the maximum of technical feasibility. The colour difference between wide-angle luminaires with high luminous flux levels (replacing fluorescent lamps) is considered excellent at 4 MacAdam ellipses.

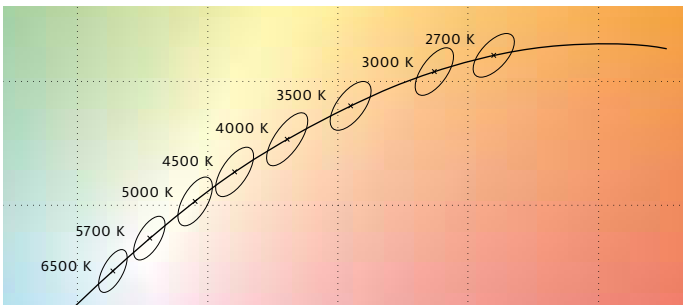

MacAdam ellipses along the Planck curve for white light

Technology used in Zumtobel’s LED modules

**Colour temperature and CCT**

*Colour temperature (CT)*

- Colour temperature, as well as light colour, in warm, neutral and daylight white
- Corresponds to colour tines in white, quoted as the Correlated Colour Temperature (CCT) in Kelvin (K)
- Colour coordinates of the Planckian radiator (Planckian curve)
- Real light sources often deviate from this: correlated colour temperature (CCT)
- Judd straight lines: all points on these lines have the same correlated colour temperature. This means that different colour coordinates can have the same CCT.

**stableWhite**

*Invariable colour temperature*

- Specific initial colour temperature (incl. tolerance range)
- Most frequent colour temperature at Zumtobel: 3000 K, 4000 K
- No readjustment in the course of the LED’s service life
- Temperature-based readjustment to keep the colour temperature constant
- Constant colour temperature during dimming

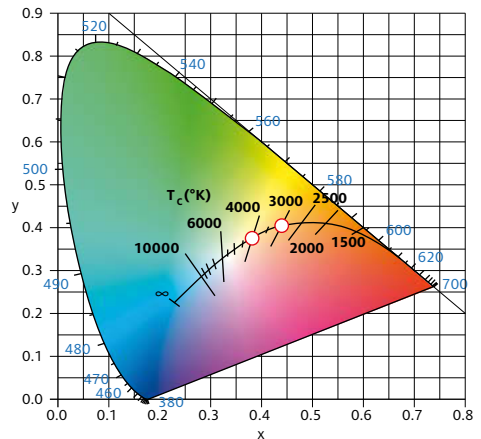
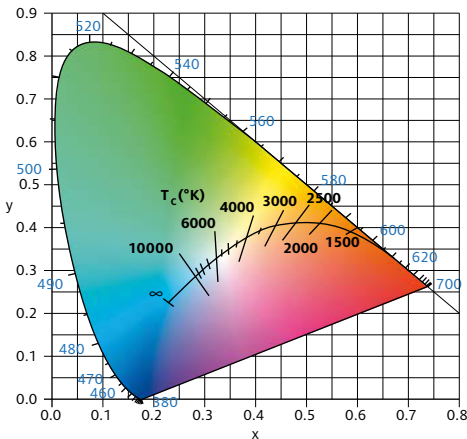



*tunableWhite* refers to the deliberate change of the colour temperature.  
A differentiation is hereby made between the following qualities:

### Balanced tunableWhite

- Manual control of two colour temperature ranges
- Colour temperature between 2700 K and 6500 K
- Brightness and/or light output depends on the control of the light colours
- Greater tolerances with MacAdams levels
- Controlled via 2 DALI device type 6 or two separate channels

### Calibrated tunableWhite

- Control of calibrated (pre-set) colour temperatures
- Colour temperatures near the Planck curve within 4 MacAdams levels
- Colour temperature between 3000 K and 6000 K
- Constant light output over the entire colour temperature range

- Constant colour temperature during dimming
- Control of the two channels via DALI device type 8

### Expert tunableWhite

- Control of the colour temperature precisely along the Planck curve (MacAdam < 4)
- Colour rendering  $R_a > 90$
- Colour temperature between 2700 K and 6500 K
- Very constant light output over the entire colour temperature range
- Constant colour temperature during dimming
- Control of several channels via DALI device type 8

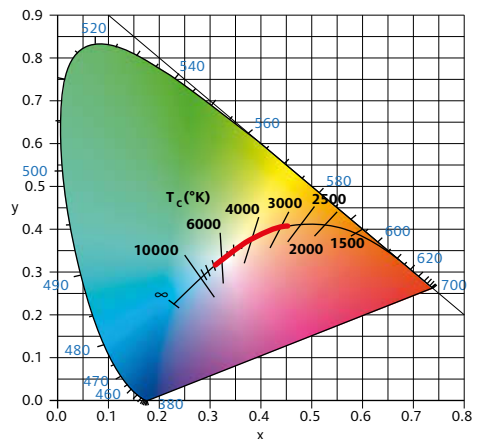
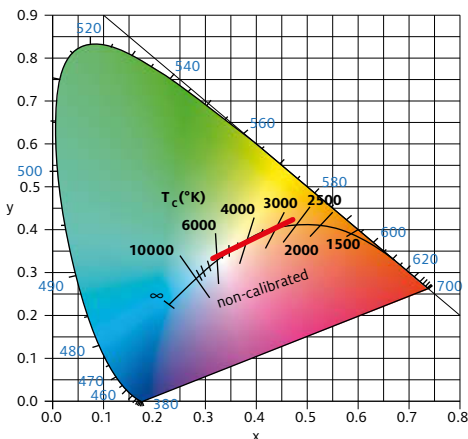

## Light control technology

### Optics

The direction of light is based on three fundamental principles: reflection, refraction and diffraction.

These principles are applied to define the photometric properties of luminaires in terms of lighting patterns.

High-precision light direction structures made of tried-and-tested as well as innovative materials extend the range with a view to both optics and design.

#### Reflection

In physics, reflection is the change in direction of a wavefront at an interface between two media with a differing refractive index so that the wavefront returns to the medium from which it originated.

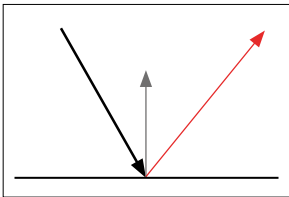
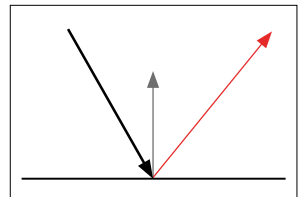

##### Specular reflection

Nearly all light is reflected according to the law of reflection (incident angle = reflected angle). The aim is to reflect as much light as possible, absorbing only little of it.

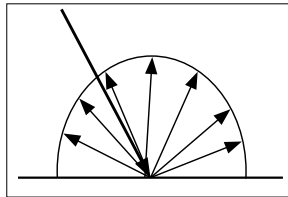

##### Lambertian reflectance

Nearly all light is reflected diffusely: light is reflected in all directions, in accordance with Lambert's law, so that the reflecting surface appears equally bright from any direction of view. Here, too, the aim is to reflect as much light as possible and absorb only little of it.

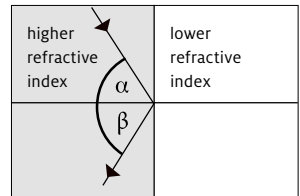

##### Total reflection

A beam of light coming from a medium with a higher refractive index that hits the boundary to a medium with a lower refractive index will be reflected away from the incident slot. If the incident angle is further increased, total reflection will occur at a critical angle. This means that the light beam does not pass out from the material with a higher refractive index, but is reflected back.

## Refraction

Refraction indicates the change in direction of a wave due to a spatial change in its rate of propagation. For light waves in particular this phenomenon is described by the refraction index of a medium.

At the transition between two media with a differing refraction index, the beam therefore changes direction according to Snell's law of refraction.

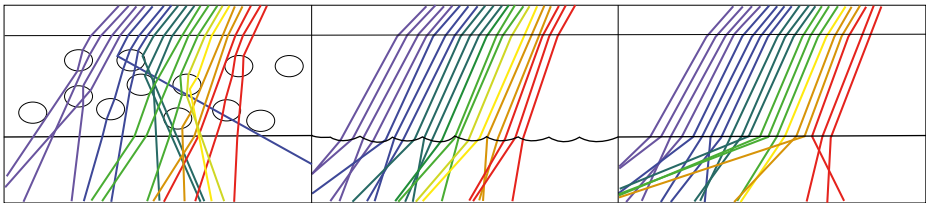
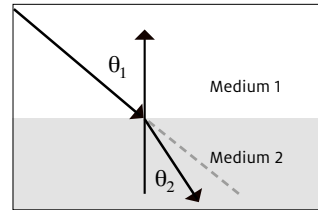

Light refraction in materials with different optical properties

Light refraction against structures such as microprisms or microlenses

Light refraction against very fine structures for thorough mixing of light

## Diffraction

If light encounters periodic structures with expansions in the wavelength of light, it is diffracted (see illustration).

Such structures may be transmission grids, reflection grids (phase grids) or holographic grids, for example. Diffraction of chromatic light results in an unfolding of the light spectrum.

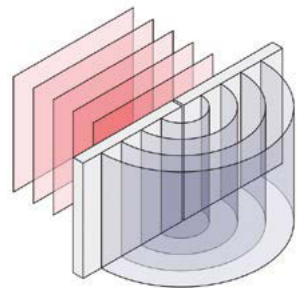

In: ZVEI Guidelines, Planning reliability in LED lighting, available from: [www.licht.de](http://www.licht.de)

## Technology and application in products

**Technology****Illustration of the principle****Functional principle**

Reflector/lens system

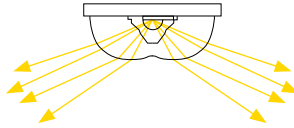

The LED's narrow-beam light is emitted through a lens and a bi-symmetrical reflector so that a narrowly targeted beam pattern is produced.

Rotating lens

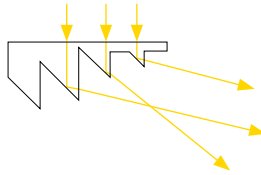

A cascading lens system redirects the vertical light beams, producing unilaterally asymmetrical distribution of light.

Lasered light guide panel

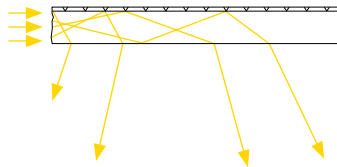

The texture applied on a transparent plastic panel using a laser results in refraction of the light injected. Thanks to the texture's varying density, the entire light guide panel can be uniformly illuminated.

Split-lens technology

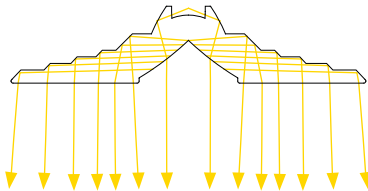

The light is guided by multiple total reflection in the lens. This produces a very homogeneous appearance of the lens with different beam angles.

## Application in products



RESCLITE escape

## Application hints/benefits

The structural design of the light control unit results in a light output ratio of the luminaire of up to 98%. Wide-angle distribution of indirect light allows uniform illumination of the ceiling even at short suspension heights.



ERI (Escape Route Illumination) in ONLITE CROSSIGN and ONLITE PURESIGN



With an installed load of only 0.5 W, the spot illuminates up to 12 m of escape route. The lens can be adjusted in increments of 90°. By using two lenses, escape route illumination can be doubled and even escape route illumination around the corner can be implemented.



ONLITE PURESIGN

This technology allows unilateral injection of light resulting in an increase in efficiency while at the same time ensuring perfect uniformity.



TECTON C

The precise direction of light allows the realisation of different beam characteristics with no additional reflectors. The luminaire cross-section and thus the appearance also remain identical.

## Light control technology

### Technology

### Illustration of the principle

### Functional principle

Micro-pyramidal optic

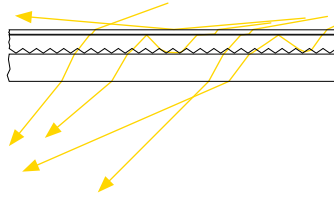

The light is coupled into the MPO panel from above. The light beams are precisely directed, resulting in a glare-reduced distribution of light that is thus suitable for use in offices. This optic is also used in a miniaturised form as MPO film.

Micro-lens optic

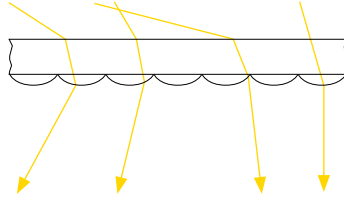

The film uses the lens effect to parallelize the light and thus produce a linear light distribution.

Virtual light source technology

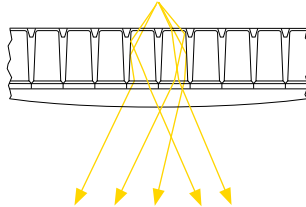

The evenly backlit cluster of lenses directs the light so that little flat light can escape from the luminaire. This results in a pleasant brightness with a high light output.

Edge-Lit technology

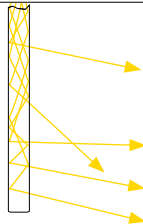

An optimised microstructure has been embossed on a transparent -plastic panel to create an asymmetric light distribution. At the same time, the luminaire's light-emitting surface appears to be homogeneously lit.

Mixing-chamber lens system

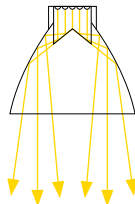

The LEDs' spectral components are united in the mixing chamber to produce white light, focussed by the lens and directed to the high-precision reflector.

### Application in products



LIGHT FIELDS, AERO, MELLOW LIGHT V

### Application hints/benefits

The luminance of the LEDs is reduced over the entire light-emitting surface, allowing a flexible arrangement of the luminaires at the workplace.



MELLOW LIGHT V

A certain percentage of the light is radiated more horizontally from the light-emitting surface. This increases the vertical luminous intensity compared to louvre luminaires and thus improves the face and object recognition as well as wall illumination.



MELLOW LIGHT evolution / infinity

The principle of backlighting and the transformation of the selective light sources on virtual, full-surface light emission creates a uniform appearance. The brightness levels are pleasant and correspond to the typical character of "mellow light".



CAELA wall-mounted luminaire

The asymmetric beam creates optimum lighting conditions in corridors through sufficient vertical luminous intensities with a -simultaneous reduction of the brightnesses in the field of view. This facilitates orientation and increases safety.



IYON

The division into mixing chamber and optic results in high modularity when using various reflectors, and hence a variety of beam patterns – from narrow-beam to wide-angle.

**Light control technology**

**Technology**

**Illustration of the principle**

**Functional principle**

Free-form reflector  
liteCarve®

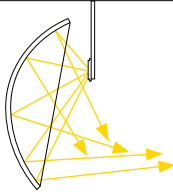

The free-form reflector offers very precise and balanced, rectangular light distribution right up to the edge areas. Used in front of an LED point light source, the reflector directs the light completely indirectly and specifically to the vertical surfaces.

Double lens system

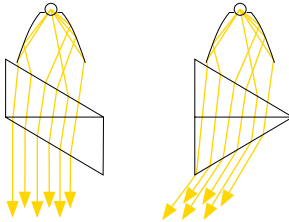

The light cone can be quickly and easily adjusted for spot-on accent lighting via the wedge-shaped lenses set into the tube. The light cone can be rotated around 360° by rotating the tube.

TIR optic with  
free-form lens

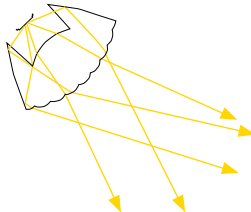

The combination of TIR optic (Total Internal Reflection) and a free-form lens array directs the relatively wide light beam of the LED in parallel.

TIR optic with snoot

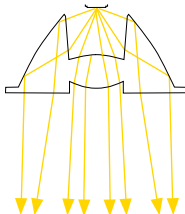

The wide light beam from the LED is directed in parallel with the help of the TIR optic (Total Internal Reflection). The desired light distributions can be achieved by using various snoots (e.g. films).



### Application in products

### Application hints/benefits



INTRO liteCarve® – also for  
3-phase tracks

A single liteCarve® luminaire creates a homogeneously lit area for which up to three spotlights previously had to be used. This simplifies planning because rectangular light distributions can be easily placed next to each other without overlaps.



PANOS infinity Adjustable

The wide ranging PANOS product group allows different beam characteristics to be achieved leading to a homogeneous visual ceiling appearance. The look of the ceiling remains soothing and unobtrusive.



SUPERSYSTEM II Wallwasher Mini

The beam characteristic of the wallwasher creates uniform wall illumination and is ideal for use in rooms up to 3 metres in height.



SUPERSYSTEM II LED spotlight

The special technology permits beam angles from Superspot (8°) to Wideflood (57°) for LED spotlights.



## Lamps

---

<b>Introduction – History of electric lighting, overview</b>	88
<b>The most important light sources</b>	90
<b>Properties of conventional lamps</b>	96
<b>Application hints</b>	97
<b>Lamp designations</b>	98

---

## Introduction – History of electric lighting, overview

Our ancestors had to make do with natural sunlight for many thousands of years. The story of how humans first learned to use light begins 500 000 years ago when they first tamed fire. It then became possible to use light and heat purposefully, and artificial lighting has extended the natural day length ever since.

Wood, tallow, fat and oil were burned to provide light for many years. It was industrialisation that brought really revolutionary changes in its wake: first gas, then electricity became the dominant method of distributing energy and producing light.

Artificial electric lighting has been an almost ubiquitous feature of everyday life for more than 130 years now. Our modern lifestyle is not viable without artificial lighting. We live in a 24-hour society and spend most of our time indoors. Even our outdoor environment is illuminated, either for traffic management purposes or to obtain decorative effects.

Demand for artificial lighting is therefore huge, and we have high expectations of it: we expect artificial lighting to be available any time, anywhere and in the required quality – and we expect it to be produced affordably and in eco-friendly ways.

Modern light sources are now highly efficient and produce good-quality light. Lighting in Europe nevertheless still accounts for 14 % of all energy consumption (and around 19 % of worldwide energy consumption).

Professional lighting accounts for approximately 80 % of this figure, and lighting in private homes accounts for roughly 20 %. That is equivalent to the emission of climate-relevant greenhouse gases amounting to roughly 600 million tonnes of CO<sub>2</sub> a year.

Saving energy that is used for lighting therefore also saves CO<sub>2</sub>. The EU has set ambitious targets intended to limit global warming to no more than 2 °C compared with pre-industrial levels: –20 % by 2020 and –40 % by 2030 compared with 1990 emission levels.

The lighting industry has come up with a wide variety of different types of lamps since 1879 when Thomas Alva Edison invented the incandescent lamp and manufactured it on an industrial scale. Individual lamps differ in terms of their design and output and, especially, the way in which they produce light. The most important criteria for modern light sources are lighting quality and efficiency – low energy consumption and a long service life.

### Light production

Light can be produced in a large number of different ways – naturally or artificially.

Light is produced cost-effectively by using four main groups of light sources:

- Thermal light sources
- Low-intensity discharge lamps
- High-intensity discharge lamps
- Semiconductor light sources

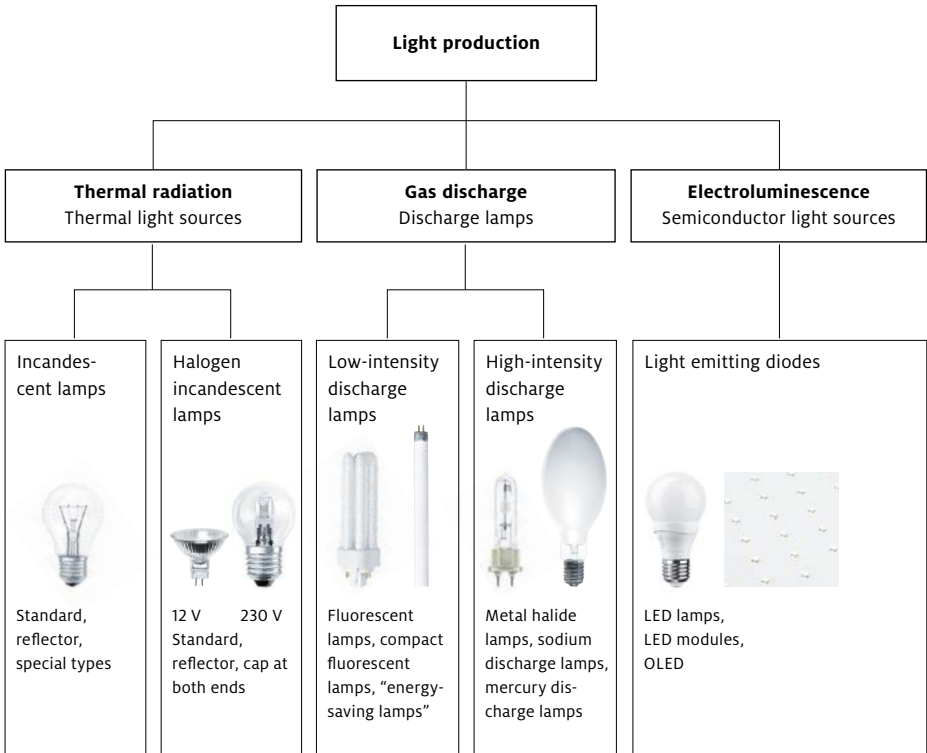

## The most important light sources



### Halogen incandescent lamps

- Mains voltage or low voltage
- Service life and luminous efficiency better than incandescent lamps
- Dimmable
- Brilliant light
- Excellent colour rendering
- *Use: retail and domestic areas, hospitality and decorative applications*

#### Functional description

Current flows through a filament and heats it up in exactly the same way as in an incandescent lamp. This is why these lamps release relatively large amounts of heat. The halogen cycle boosts the efficiency and prolongs the service life of these lamps compared with conventional incandescent lamps.

Low-voltage lamps are very compact and therefore ideally suitable for directing light precisely, but they do need a transformer.

Due to European legislation, only the most energy-efficient versions of this lamp group are permitted.

More efficient alternatives include compact fluorescent lamps with built-in electronic ballasts or LED lamps.

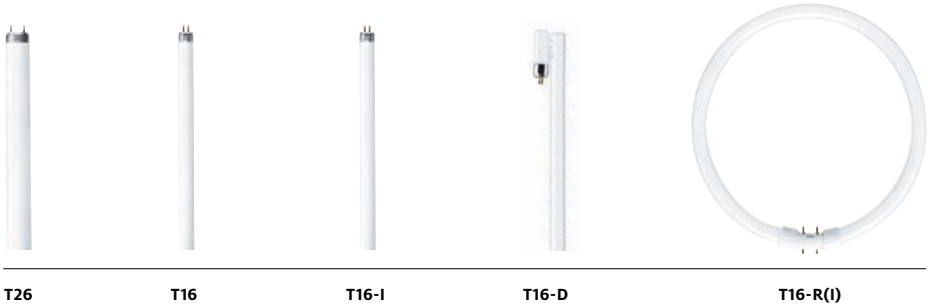

## Fluorescent lamps

- High to very high luminous efficiency (especially T16 HE)
- Good to very good colour rendering
- Long service life
- Wide selection of standard ranges
- Dimmable
- *Use: efficient wide-area lighting*

### Functional description

An alternating electrical field between two electrodes in the discharge tube produces invisible UV radiation. The tube's white fluorescent coating converts this radiation into high-quality, visible light.

These lamps need ignitors and current limiting; these functions are combined in an electronic ballast.

The luminous flux of fluorescent lamps is highly dependent on their operating position and ambient temperature. Lamps that use amalgam technology are optimised for use in environments where there are fluctuating temperatures (see page 97).

## The most important light sources



### Compact fluorescent lamps

- Compact designs
- High luminous efficiency
- Excellent colour rendering
- Wide selection of standard ranges
- Dimmable
- *Use: commercial and prestigious areas, hospitality*

#### Functional description

These lamps are compact versions of tubular or toroidal fluorescent lamps and operate in a very similar way.

The luminous flux of these lamps is highly dependent on their operating position and ambient temperature. Lamps that use amalgam technology are optimised for use in environments where there are fluctuating temperatures.





## Metal halide lamps

- High luminous efficiency
- Good to very good colour rendering
- Good colour stability in case of lamps with ceramic discharge tubes
- Usually not dimmable
- *Use: industrial bays, spotlighting, floodlighting systems, retail areas*

### Functional description

Metal halide lamps maintain an extremely compact electric arc in a discharge tube. Lighting quality is determined by the composition of the materials the lamp contains.

An ignitor is needed to start the lamp and the current must be limited by a ballast. Electronic ballasts can advantageously be used for low-power lamps.

Lamps with a ceramic discharge tube offer the best lighting quality, efficiency and service life.

## The most important light sources



HST-CRI



HSE



HST



HST-DE

## High-pressure sodium discharge lamps

- High luminous efficiency and long service life
- Satisfactory to poor colour rendering
- Yellowish light colour
- Can be dimmed in steps
- *Use: industrial bays, street lighting, outdoor illumination*

### Colour-improved (Philips SDW):

- Warm, white light
- Excellent colour rendering
- *Use: retail areas*

### Functional description

Discharge in the elongated ceramic discharge tube is determined by sodium. The light therefore has a yellow hue and is only suitable for specific applications.

Philips colour-improved SDW produces very good quality white light and is a popular choice for lighting in retail spaces.

An ignitor is generally needed to start the lamp. The current must be limited by a ballast.



LED lamp



LED module

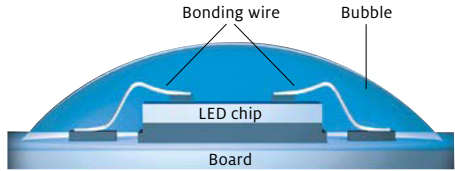

## Light emitting diodes (LEDs)

- Very efficient light production
- Wide selection of standard ranges
- Can be switched and dimmed as required
- Very long service life
- Good to very good colour rendering
- Very good production of coloured light
- *Use: LEDs can be used for both functional and decorative lighting in indoor and outdoor locations.*

### Functional description

Light emitting diodes are modern semiconductor devices. Their characteristics are determined by their materials, mechanical design and operating mode. The active semiconductor layer, in which radiation is pro-

duced, is sandwiched between a positive and a negative substrate inside the LED. Actual coloured light is produced, depending on which materials are chosen. Nowadays, high-quality white light is produced by blue LEDs with yellow luminescent substances. A mixture of RGB (red, green, blue) also produces white. The smallest LED chips have a side length of approx. 250  $\mu\text{m}$  (1 micrometre = 1 one thousandth of a millimetre). As a rule, they are powered via appropriate DC converters. Their very long service life of over 10 000 hours demands optimised thermal management in order to prevent overheating.

Today, LEDs are already some of the most efficient light sources for general lighting. They are completely superseding traditional light sources in many applications.

More information about LEDs can be found in Chapter 4 – Technology.

## Properties of conventional lamps

Conventional lamps today are normally only used as replacements. Nevertheless, there are reasons as to why efficient conventional lamps should still be used. Some properties that have to be taken into account when working with these lamps are listed below.

On account of their high luminous efficiency and long service life, LED light sources

in particular are dominating all applications. They can rightly be viewed as the light source of the future.

It is therefore up to the expertise of the planner to find the best possible light source for any lighting task.

The key parameters of lamps can essentially be defined by the following terms:

### Warm-up time

Discharge lamps in particular need between 30 seconds and several minutes to warm up and output the full luminous flux.

### Re-start

High-pressure discharge lamps need to cool down for several minutes before they can be started again.

### Dimmability

As well as incandescent and halogen incandescent lamps, almost all fluorescent and compact fluorescent lamps can be dimmed as required nowadays. Most manufacturers' metal halide lamps continue to be incompatible with dimming because dimming may have uncontrolled effects on lighting quality and lamp service life. The new series of special models for indoor and outdoor applications constitute an exception. The output of sodium vapour lamps and high-pressure mercury lamps can be restricted in stages. LED light sources can be switched and dimmed as required.

### Operating position

Manufacturers specify the permitted operating positions for their lamps. For some metal halide lamps, only certain operating positions are allowed so as to avoid unstable operating states. Compact fluorescent lamps may usually be used in any operating position; however, important properties such as the luminous flux vs. temperature curve may vary with the position.

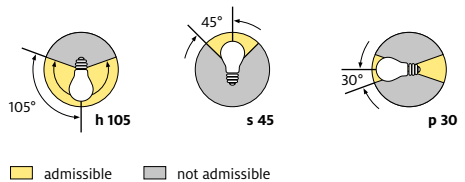

## Application hints

### T16 fluorescent lamps

In comparison with thicker T26 lamps (diameter: 26 mm), modern T16 lamps (diameter: 16 mm) show several different properties that must be taken into account for application.

#### Luminous flux – temperature curve

As for all fluorescent lamps, the lamp's luminous flux is temperature-dependent. The maximum value is obtained at an optimum ambient temperature, with losses increasing at higher and lower temperatures. The T16 basically follows the same curve as the T26, but the maximum occurs not at an ambient temperature of 20 to 25 °C but at about 35 °C.

Reason: the cool spot of T16 is not located in the centre of the lamp, but typically at one end of the tube where the manufacturer has fixed its seal.

The rated luminous flux is generally specified for an ambient temperature of 25 °C. For the T16, the maximum value therefore lies above this rated value. Thus luminaire efficiencies may have levels greater than "1".

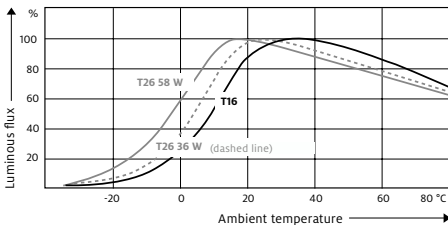

#### Amalgam technology

Special T16-I lamps with amalgam technology are available in order to ensure that the luminous flux is slightly less temperature dependent.

Adding amalgam (a mercury compound) makes it possible to compensate for the decrease in luminous flux at relatively high and low temperatures.

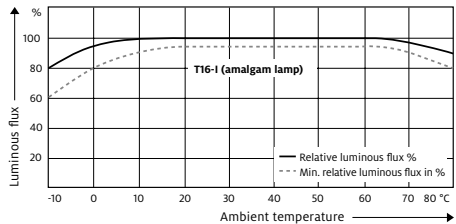

## Lamp designations

Various systems are used to designate lamps. Lamp manufacturers use their own product name for each lamp. And there are standards and non-proprietary documents that use general designations. The LBS<sup>1</sup> coding system, which was devised by the Central Association of German Electrical and Electronic Industries (ZVEI), provides an extremely useful overview. Every general lighting lamp can be precisely designated according to the LBS coding system by an abbreviation consisting of letters and numbers.

Many luminaire manufacturers use the LBS coding system to specify appropriate lamps for their luminaires regardless of the names used by lamp manufacturers. This makes sense because many lamps are standardised and are therefore interchangeable regardless of make. International standards use another system – ILCOS<sup>2</sup>.

The table below compares the designations used in various systems.

<b>LBS (ZVEI)</b>	<b>ILCOS</b>	<b>OSRAM</b>	<b>PHILIPS</b>	<b>GE</b>	<b>SYLVANIA</b>
A60	IAA	TR	CLASSIC TONE	A1	Normal
QR-CBC	HRGI	DECOSTAR S	MASTERline	Precise MR	Professional
QPAR	HEGPAR	HALOPAR	PAR	PAR	Hi-Spot
TC	FS	DULUX S	PL-S	BIAX S	Lynx CF-S
TC-T	FSM	DULUX T	PL-T	BIAX T	Lynx CF-T
TC-L	FSD	DULUX L	PL-L	BIAX L	Lynx CF-L
T16	FDH-G5-16	FH, FQ	TL'S HE, HO	T5 XL	FHE, FHO
T26	FD-G13-26	L	TL'D	T8	F
HME	QE	HQL	HPL	H	HSL
HIT	MT	HQI-T, HCI-T	MHN/W-T, CDM-T	Arcstream T, Kolarc T, CMH	HSI-T, CMI-T
HST	ST, STM, XX	NAV-T	SON-T, SDW-T	Lucalox T	SHP-T

<sup>1</sup> **LBS** = **L**ampen-**B**ezeichnungs-**S**ystem [Lamp Code System], a standardised system for designating electric lamps for general lighting (luminaire manufacturers)

<sup>2</sup> **ILCOS** = **I**nternational **L**amp **C**oding **S**ystem (lamp manufacturers), Standard IEC TS 61231/DIN 49805

### Example of general description of a fluorescent lamp using the LBS coding system:

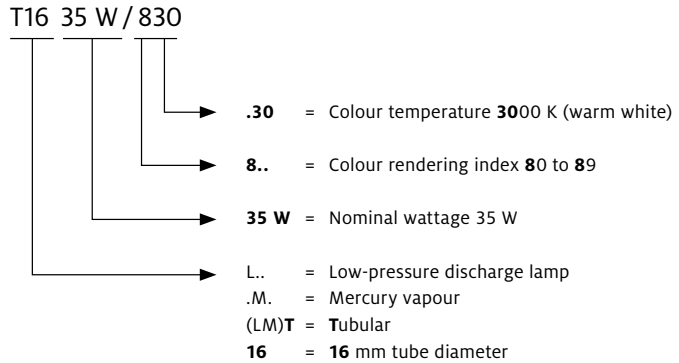

The LBS lamp coding system makes it possible to designate a fluorescent lamp precisely.

Redundant or unambiguous details may sometimes be omitted, for instance “LM” for “low-pressure mercury vapour discharge lamp” as in this example.

Besides this basic data, further details can be specified depending on the lamp:  
 bulb colour, clear or frosted,  
 radiation angle in case of reflector lamps,  
 description of cap/lampholder,  
 permissible voltage etc.





## Lighting control and control gear

---

### Communication protocols

Terminology and circuit diagram	102
DALI: General information   Features	103
Device type	104
DSI: General information   Features	105
Differences between DALI and DSI	105
DALI and DSI: Control line	106
LUXMATE bus:	
General information   Features	
Bus domain and bus power supply	107
Bus line and cable lengths	108
Comparison: LUXMATE bus – KNX (EIB)	109
DMX: General information   Features   System design	110

---

### Lighting control systems

LUXMATE: Simple dimming	112
switchDIM: General information   Wiring scheme	113
CIRCLE KIT: General information   Wiring scheme	114
LUXMATE: Overview of lighting control systems	116
LUXMATE DIMLITE:	
General information   Overview	117
Selection according to control gear and functionality	119
Basic wiring: Dimming via	
momentary-action switch using	120
Basic wiring: Daylight-based dimming using	122
Basic wiring: Multifunctional lighting control	124
LITECOM: General information	126
LITECOM infinity: General information	127
Overview circuit for a LITECOM system	128
Overview circuit for a LITECOM infinity system	130
LUXMATE LITENET:	
General information   Overview circuit	132
LUXMATE lighting management:	
Overview   Functions   Product ranges	136
Differentiation between DALI (EMOTION, LITENET) and DMX (E:cue)	138

---

### Control devices

Functions overview	139
--------------------	-----

---

## Communication protocols

### Terminology and circuit diagram

- A *bus* is a system for transferring data between *several* participants via a joint transmission path.
- In electronic engineering, a *control line* is a connection (cable, wire) between *one* transmitter and one receiver. Via this connection the receiver is switched to a different operating mode. Communication is either *bidirectional* (DALI) or just *uni-directional* (DSI).
- A *communication protocol* is an agreement according to which data transfer between two or more participants is carried out. In its most simple form, a protocol can be defined as the rules determining the structure, meaning and synchronisation of communication.

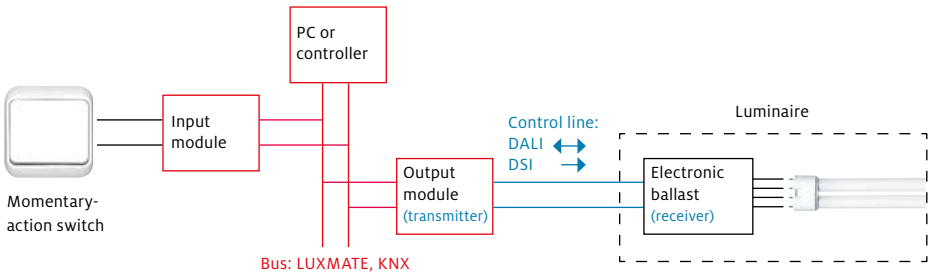

## DALI: General information

- The term DALI stands for “Digital Addressable Lighting Interface”.
- DALI is not a building management bus system, but a protocol *for digital addressing of technical lighting control gear*.
- DALI is a standard defined by several manufacturers of luminaires and electronic ballasts: IEC 60929 allows the combination of devices of various manufacturers. However, the standard defines only output devices (control gear), not input devices such as sensors or control units. Hence, input devices with DALI connection are addressed in a manufacturer-specific way!
- IEC 62386 specifies requirements placed on control gear allocated to specific types of device.

## DALI: Features

- Usable data transmission rate: 1200 bit/s
- Max. *64 control units* per control circuit
- Max. *16 groups* per control gear can be assigned
- Max. *16 scenes* per control unit can be programmed
- Bidirectional: reports information such as faulty lamps, dimming levels etc.
- Max. *system current of 250 mA* from central interface supply (each electronic ballast takes up a maximum of 2 mA of current load)
- Two-wire control line (potential-free, polarity-free, unshielded, no terminal resistors)
- Voltage drop between transmitter and receiver *must not be more than 2 V*
- Application: general lighting (small number of lighting points, static light)

## Communication protocols

### DALI: Device type

IEC subcommittee SC 34C is in charge of the IEC 62386 “Digital addressable lighting interface” series of standards.

<b>IEC 62386-1xx</b>	<b>Parts 1xx: General requirements</b>
IEC 62386-101:2009-06	Part 101: System
IEC 62386-102:2009-06	Part 102: Control devices
<b>IEC 62386-2xx</b>	<b>Parts 2xx: Particular requirements for control gear</b>
IEC 62386-201:2009-06	Part 201: Fluorescent lamps (device type 0)
IEC 62386-202:2009-06	Part 202: Emergency lighting with separate battery (device type 1)
IEC 62386-203:2009-06	Part 203: Discharge lamps (except fluorescent lamps) (device type 2)
IEC 62386-204:2009-06	Part 204: LV halogen lamps (device type 3)
IEC 62386-205:2009-06	Part 205: Supply voltage controllers for incandescent lamps (device type 4)
IEC 62386-206:2009-06	Part 206: Conversion from digital signal into D. C. voltage (device type 5)
IEC 62386-207:2009-06	Part 207: Particular requirements for control gear – LED modules (device type 6)
IEC 62386-208:2009-06	Part 208: Switching function (device type 7)
IEC 62386-209:2011-06	Part 209: Colour/colour temperature control (device type 8)
IEC 62386-210:2011-04	Part 210: Sequencer (device type 9)

## DSI: General information

- The term DSI stands for “Digital Serial Interface”.
- DSI is not a building management bus system, but a protocol *for digital addressing of technical lighting control gear*.
- DSI is a manufacturer-specific interface defined by Zumtobel.
- DSI is the predecessor of DALI with the main goal of replacing analogue addressing (1–10 V) of control gear with digital addressing.
- Devices with DSI and DALI connection are not compatible and cannot be used jointly in one control circuit.

## DSI: Features

- Usable data transmission rate: 1200 bit/s
- Depending on the output module:  
*10 to 100 control units per control circuit*
- Max. *20 scenes* per control unit can be programmed
- Unidirectional: reports only faulty lamps (depending on the technical design of the electronic ballast)
- Two-wire control line (potential-free, polarity-free, unshielded, no terminal resistors)
- Application: general lighting (small number of lighting points, static light)

## Differences between DALI and DSI

- Each DALI control unit may have different intensity levels, while all DSI (and 1–10 V) control units always have the same intensity level.
- With DSI, units are allocated to groups by wiring; with DALI, group allocation is performed via software.
- With DSI (and 1–10 V), only a unidirectional flow of information (from the controller to the controlled unit) is possible.
- DSI and DALI units cannot be operated jointly in one control circuit.

## Communication protocols

### DALI and DSI: Control line

- Any type of insulated line for mains voltage is admissible if the voltage drop is not more than 2 V at 250 mA.
- DALI components are usually powered via a separate mains power supply.
- The insulation of the digital interface complies with basic insulation requirements; verification is effected in accordance with the IEC 60928 standard. Thus, SELV (Safety Extra Low Voltage) is not guaranteed.
- The cables connecting the digital interface with the mains power supply lines (e.g. 230 V) may be relocated if the insulation conditions (2 x basic insulation) are maintained. The two “free” wires of a 5 x 1.5 mm<sup>2</sup> NYM cable are frequently used as control lines (together with the other wires for phase, neutral and protective ground conductors).

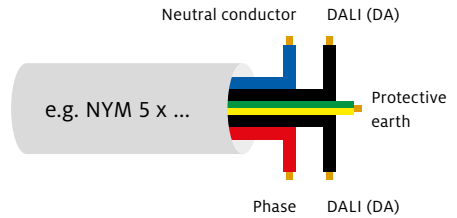

Cross-section	Length
2 x 0.50 mm <sup>2</sup>	116 m
2 x 0.75 mm <sup>2</sup>	174 m
2 x 1.00 mm <sup>2</sup>	232 m
2 x 1.50 mm <sup>2</sup>	300 m

## LUXMATE bus: General information

- Proprietary bus developed by Zumtobel, so that a combination of devices by different manufacturers is *not* possible
- *Bus domain*, the smallest logical unit
  - Max. 99 rooms
  - Max. 99 addresses per room
  - Max. 99 groups per room
  - Max. 500 devices connected to bus coupler (max. 100 devices per bus power supply)

## LUXMATE bus: Features

- Usable data transmission rate: 2400 bit/s
- Max. 20 scenes per control unit can be programmed
- Bidirectional: reports information
- Two-wire control line (potential-free, polarity-free, unshielded, no terminal resistors)
- *Loop resistance* for entire line within one bus domain must not exceed 11 ohms
- Total length of line: max. 1000 m (with 2 x 1.5 mm<sup>2</sup>)
- Dimming range 1 to 100 %
- Application: general lighting (large number of lighting points, static light)

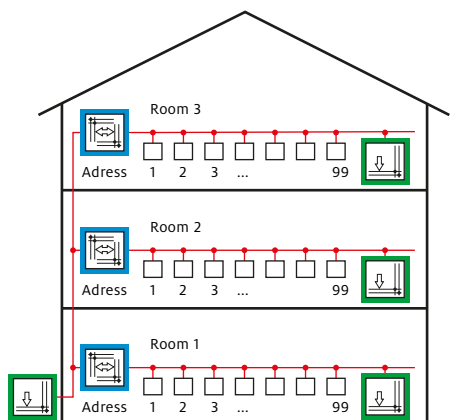

## LUXMATE bus: Bus domain and bus power supply

- *Bus domain*
  - Smallest logical unit
  - Max. 99 rooms
  - Max. 99 addresses per room
  - Max. 500 devices connected with bus coupler
- *Bus power supply*
  - LM-BV: maximum of 100 modules
  - LM-BVS35: maximum of 35 modules



**LM-BV (LM-BVS35)** bus power supply



**LM-BK** bus coupler

## Communication protocols

### LUXMATE bus: Bus line and cable lengths

#### Bus line

- Twisted two-core line (1 lay each 5 metres) for low-voltage installation

#### Cable lengths

- Overall length for one bus power supply: max. 1000 m
- Between LUXMATE devices (AB):
  - Max. 350 m with 2 x 0.75 mm<sup>2</sup>
  - Max. 500 m with 2 x 1.5 mm<sup>2</sup>
- From bus power supply to the most distant LUXMATE device (A,B):
  - Max. 350 m with 2 x 0.75 mm<sup>2</sup>
  - Max. 500 m with 2 x 1.5 mm<sup>2</sup>
- Loop resistance in a bus circuit must not exceed 11 ohms (applies to all components of the bus power supply).
- Bus and mains in one cable (5 x 1.5 mm<sup>2</sup>) are admissible only for 5 m stub lengths each.
- For tracks/trunking: bus lines should be cross-linked at least every 7 m.

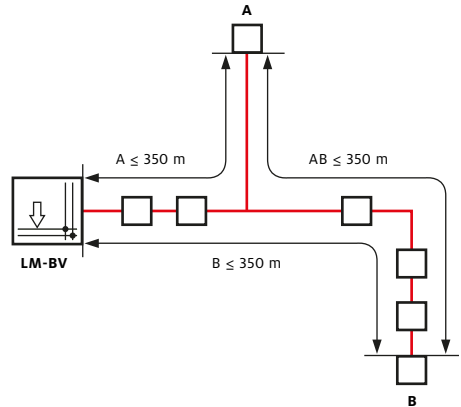

Cross-section	Length
2 x 0.50 mm <sup>2</sup>	150 m
2 x 0.75 mm <sup>2</sup>	250 m
2 x 1.00 mm <sup>2</sup>	300 m
2 x 1.50 mm <sup>2</sup>	500 m

#### Cable length test report LUXMATE PROFESSIONAL

**Voltage measurement (VOLT):** measurement between B1 and B2 – D.C. voltage

**Current measurement (AMPERE):** measurement at B1 or B2 – measured value must not exceed 150 mA

**Loop resistance (OHM):** 1) disconnect LM-BV from power, 2) establish wire bridge at LM-BV between B1 and B2, 3) perform measurement at the last actuator of the bus line between B1 and B2.

*The loop resistance measured must not exceed 11 ohms!*

*If a loop resistance between 14 and 16 ohms is measured, the service report must indicate that the bus line is too long; electrician must be informed!*

*If the loop resistance measured is 16 ohms or higher, commissioning will be terminated!*

#### The cable length is calculated as follows:

Cable length = loop resistance x rho x cross-section / divided by two

$$L = R \times \rho \times A / 2$$

A = cross-section/rho = 56 for copper

#### LUXMATE guidelines:

1.5 mm<sup>2</sup> cross-section = max. bus line of 500 m

1.0 mm<sup>2</sup> cross-section = max. bus line of 300 m /

with 2 x 2 x 0.8 cable, both pairs must be connected

0.75 mm<sup>2</sup> cross-section = max. bus line of 250 m

0.5 mm<sup>2</sup> cross-section = max. bus line of 150 m



## Comparison: LUXMATE bus – KNX (EIB)

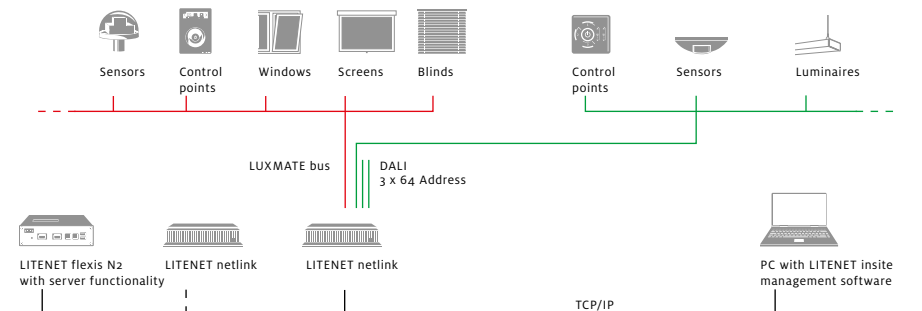

### LUXMATE

- Standard cables are used for installation
- Protected against reversed polarity!
- General operation immediately after installation (installation test)
- Easy addressing from each location within the building

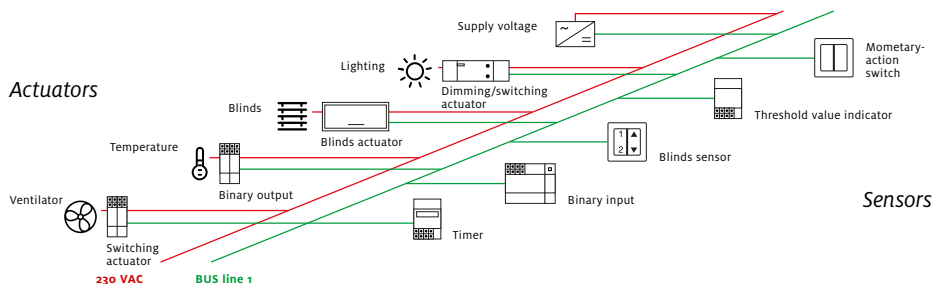

### KNX

- A specially shielded EIB cable must be used for installation
- Not protected against reversed polarity (+/-)
- No operation possible without addressing (no installation test)
- Addressing only directly on the luminaire and via control points using special ETS software

## Communication protocols

### DMX: General information

DMX was developed in the United States for stage equipment in 1986. Previously, the slider settings for spotlights were converted to analogue voltage levels between 1 and 10 V. Subsequently these voltages were transmitted in parallel to the dimmers via one control line for each spotlight.

This analogue dimming worked well with a small number of spotlights. However, stages and shows became bigger and bigger. The cabling included a large number of parallel 1–10 V control lines became too complex and inflexible.

Only the positions of the slider have been converted to digital values for the DMX. ALL dimming levels are then transmitted one after the other via ONE joint control line.

### DMX: Features

- Usable data transmission rate: 250 000 bit/s
- Refresh rate: 30 times per second
- Max. 512 channels (addresses) per universe (control circuit)
- Max. of 32 luminaires directly one after the other; for more luminaires, a splitter is required
- Unidirectional: no information is reported
- Two-wire control line (shielded, terminal resistance)
- Application: illumination of façades (large number of lighting points, dynamic light)

## DMX: System design

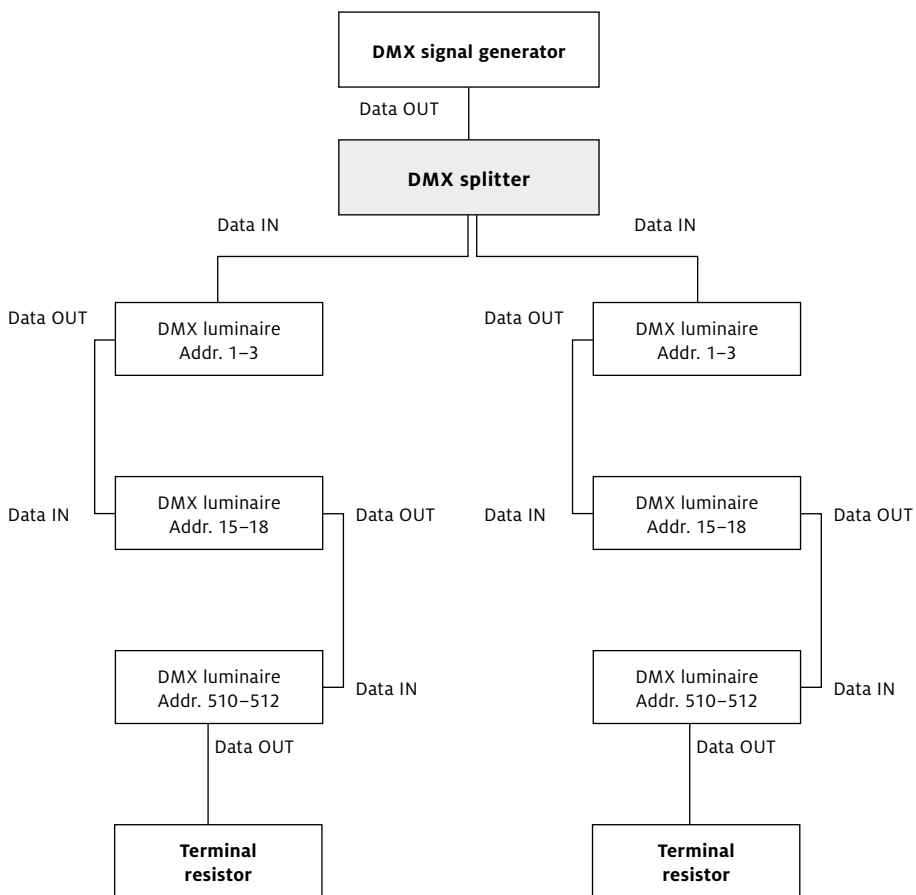

max. 32 receivers in case of standard DMX connection

## Lighting control systems

LUXMATE: Simple dimming

### switchDIM

Dimming for individual or multiple luminaires



### CIRCLE KIT

Lighting scenes for luminaire groups



### switchDIM: Wiring scheme



## switchDIM: General information

### Benefits

- Easiest way of dimming an *individual luminaire* or a small group of luminaires
- Only a conventional *momentary-action switch* is required
- No addressing necessary

### Features

- Function:
  - Switching by pressing the button briefly
  - Dimming by pressing the button longer
- Asynchronous dimming: switching time (approx. 0.2 seconds) depends on the timer in the control unit. Due to component tolerances, there is no exact switching point for several luminaires within a group. Asynchronicity may occur.
- Recommendation: use switchDIM for no more than 2 luminaires. If more luminaires are involved, a controller such as DIMLITE single is feasible.
- Works only with a momentary-action switch, not with a regular switch!

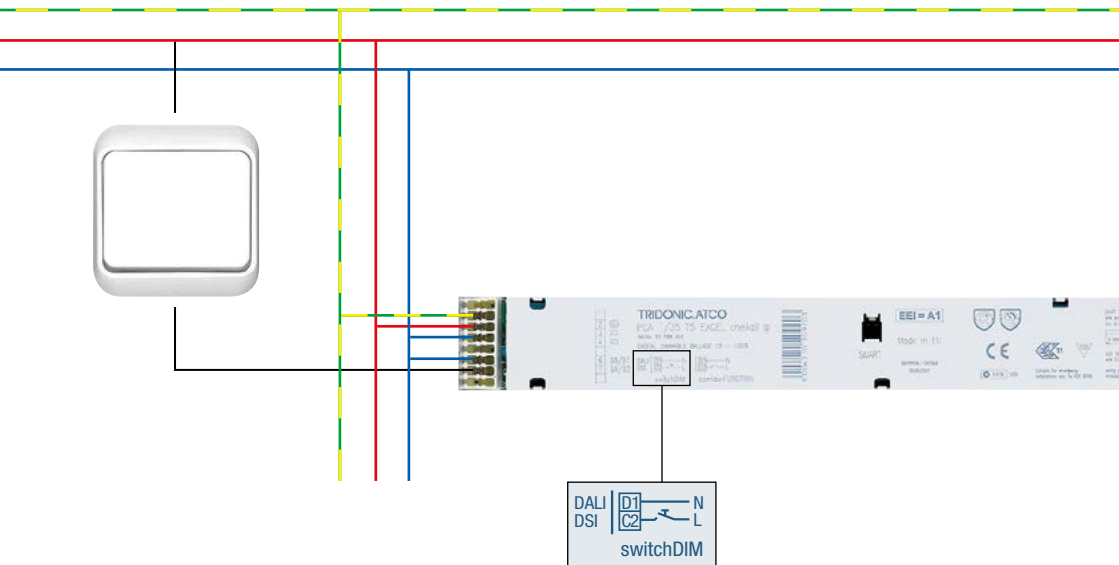

Wiring of electronic ballast with switchDIM function.

## Lighting control systems

### CIRCLE KIT and CIRCLE tune KIT: General information

#### Benefits

- CIRCLE KIT: easiest way of applying *lighting scenes*
- CIRCLEtune KIT: easiest way of using *colour temperature control*
- Commissioning and operation via CIRCLE CSx control point
- Several CIRCLE control points can be connected in parallel
- Bus power supply already included in the package

#### Features

- 3 lighting scenes can be individually programmed
- Dimming of 2 luminaire groups
- Bus power supply for up to 64 DALI-dimmable luminaires
- One CIRCLE control point covers 3 DALI loads
- Control point available in white and silver

#### CIRCLE KIT: Wiring scheme

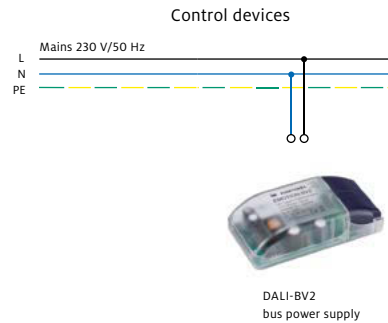

#### CIRCLEtune KIT: Wiring scheme

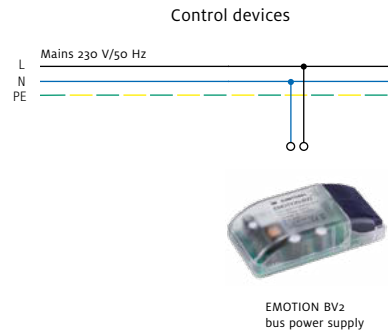

- L** phase
- N** neutral
- PE** protective earth
- D** control line
- ⊕ earth
- = AC voltage

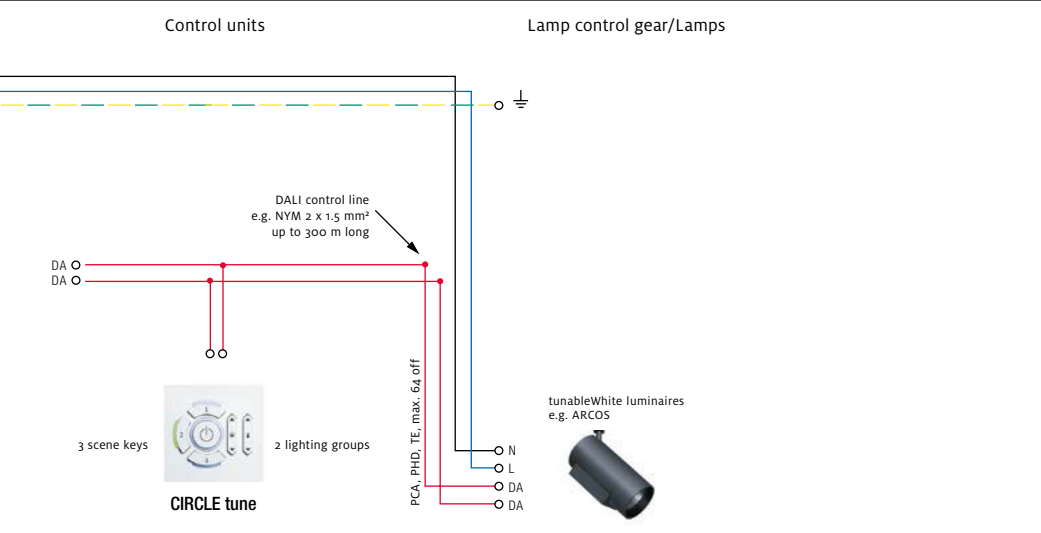
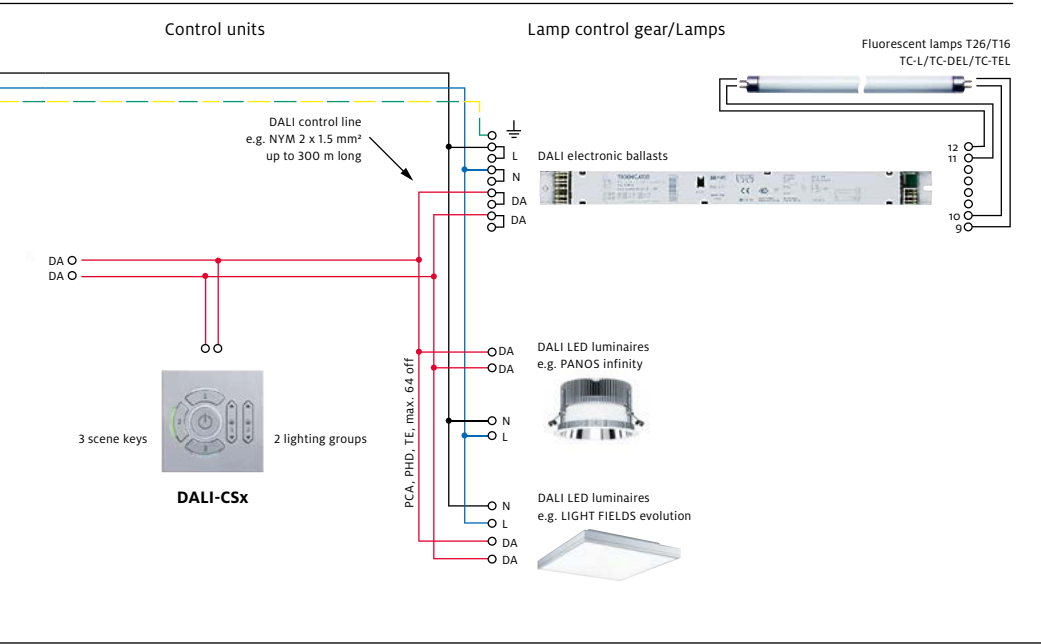

## Lighting control systems

### LUXMATE: Overview of lighting control systems

#### LUXMATE DIMLITE

Lighting management for individual rooms

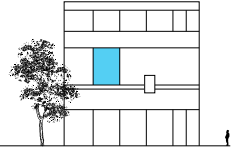

#### LITECOM

Lighting management for smaller buildings

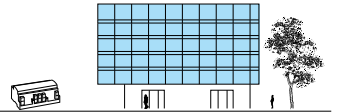

#### LITECOM infinity

Lighting management for buildings and building complexes

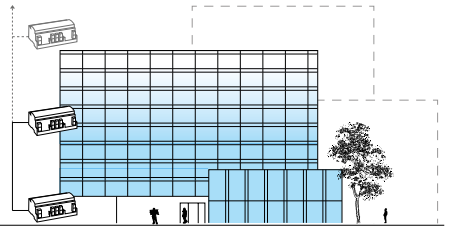

#### LUXMATE LITENET / PROFESSIONAL

Lighting management for buildings with lighting and blinds control

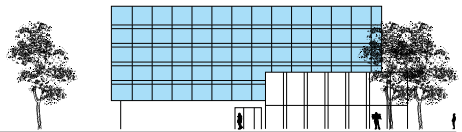

#### DMX lighting management

Dynamic lighting scenarios for outer façades

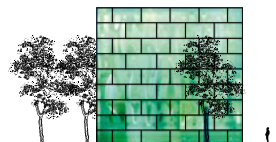



## LUXMATE DIMLITE: General information

### Benefits

- Synchronous dimming
- AUTO detect: DALI and DSI outputs with automatic identification (mixed operation not admissible)
- AUTO setup: automatic initialisation, no addressing necessary
- Reduction of stand-by losses: automatic power disconnection of lighting actuators via integrated relay
- Operation using all conventional 230 V momentary-action light switches; several momentary-action switches can be connected in parallel

### Features

- 2 models: for installation in switch cabinet for 2 or 4 luminaire groups, and for installation in luminaire or recessed into ceiling for 2 or 4 luminaire groups, including strain relief
- Up to 3 lighting scenes, of which scene 1 features daylight-based control (depending on additional devices)
- Modular range of functions, to be individually combined:
  - daylight-based control
  - presence detector (ONLY OFF, ON/OFF, CORRIDOR with 10% dimming level)
  - IR remote control
  - CIRCLE comfort control point (2 groups, 3 scenes)
  - scene or group module

## Lighting control systems

## LUXMATE DIMLITE: Overview

	Size of system			Functions			Components to be integrated			
	Number of groups	Number of DALI luminaires	Number of DSI luminaires	Dimming	Lighting scene	Control by momentary-action switch	Presence detector	Daylight-based control	Convenience control point	Remote control
DIMLITE basic module										
<b>DIMLITE single*</b>	1	25	25	■	■	■	■			
<b>DIMLITE daylight*</b>	2	50	50	■	■	■	■	■		
<b>DIMLITE multifunction 2ch**</b>	2	50	100	■	■	■	■	■	■	■
<b>DIMLITE multifunction 4ch**</b>	4	100	200	■	■	■	■	■	■	■

\* for installation in luminaire or recessed into ceiling

\*\* for installation in switch cabinet (DIN rail mounted device)

## LUXMATE DIMLITE: Selection according to control gear and functionality



### 1. Select appropriate lamp control gear

Lamps	Dimming range	All control gear with DALI/DSI control input
GLS lamps	0–100%	Phase dimmer: 500–1000–5000 VA
PAR lamps	0–100%	Phase dimmer: 500–1000–5000 VA
HV halogen incandescent lamps	0–100%	Phase dimmer: 500–1000–5000 VA
LV halogen incandescent lamps	0–100%	electronic dimmable transformer: 105 VA + 150 VA
Fluorescent lamps	1–100%	electronic dimmable ballast
LED	0–100%	electronic dimmable LED converter 1 ch./3 ch.

### 2. Select control function required

Function	Control	Module name for DSI/DALI/dim <sup>2</sup> save
1-channel dimming, lighting scene, presence	momentary-action switch, presence detector	DIMLITE single
2-channel dimming, daylight, presence	momentary-action switch, presence detector, light sensor	DIMLITE daylight
2- or 4-channel multifunction	momentary-action switch, Circle, light sensor, presence detector, IR remote control unit	DIMLITE 4ch* (4-channel)

All modules available for installation in luminaire or recess into ceiling

\* only available as housing for installation in switch cabinet

## Lighting control systems

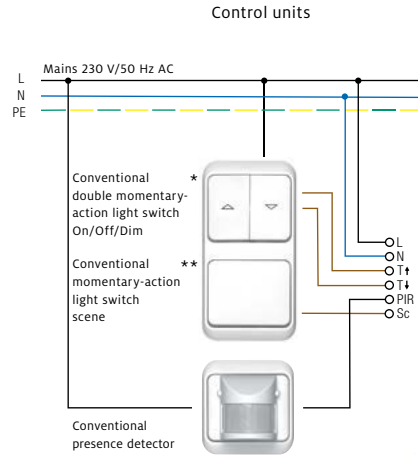
LUXMATE DIMLITE basic wiring:  
Dimming via momentary-action switch using

\* Saving the pre-set lighting level

\*\* Alternative:  
When using a single momentary-action switch, fit jumper on terminal "T↑" and "T↓"

**L** phase  
**N** neutral  
**PE** protective earth  
**T** momentary-action switch input  
**D** control line  
 ⊕ earth  
 = AC voltage

Control devices

Lamp control gear

Lamps

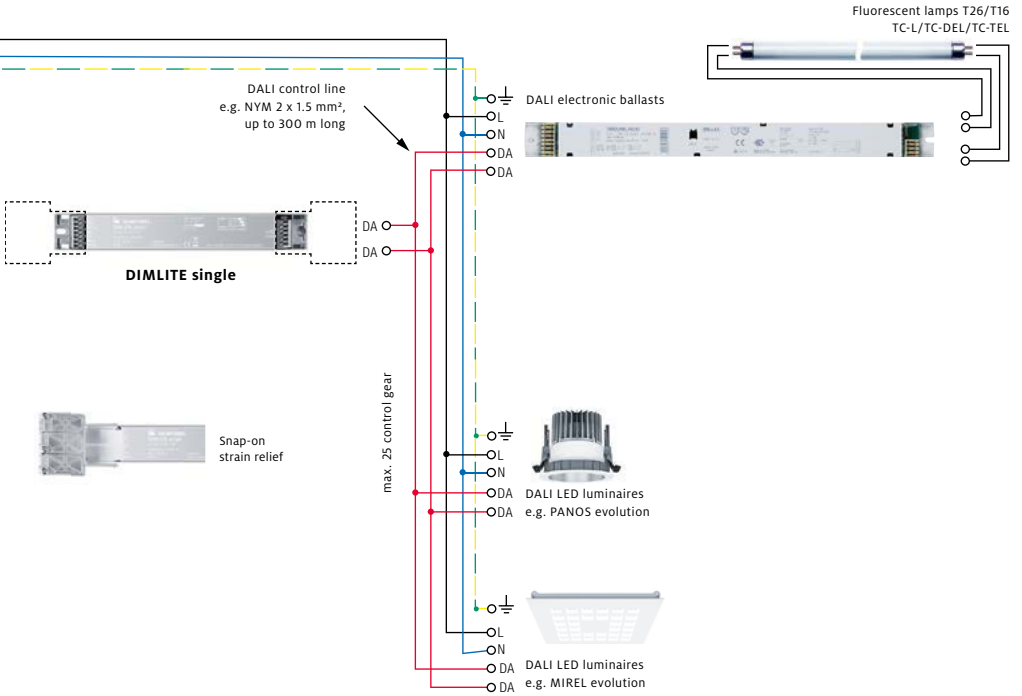

Lighting control systems

LUXMATE DIMLITE basic wiring:  
Daylight-based dimming using

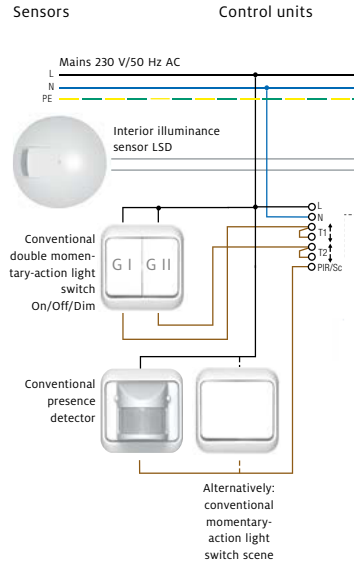

- L** phase
- N** neutral
- PE** protective earth
- T** momentary-action switch input
- D** control line
- ⊕ earth
- = AC voltage

Control devices

Lamp control gear

Lamps

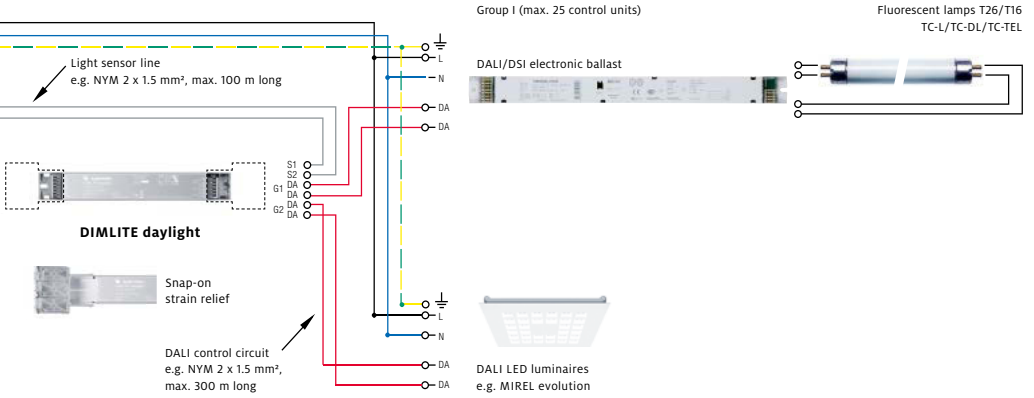

Lighting control systems

LUXMATE DIMLITE basic wiring:  
Multifunctional lighting control

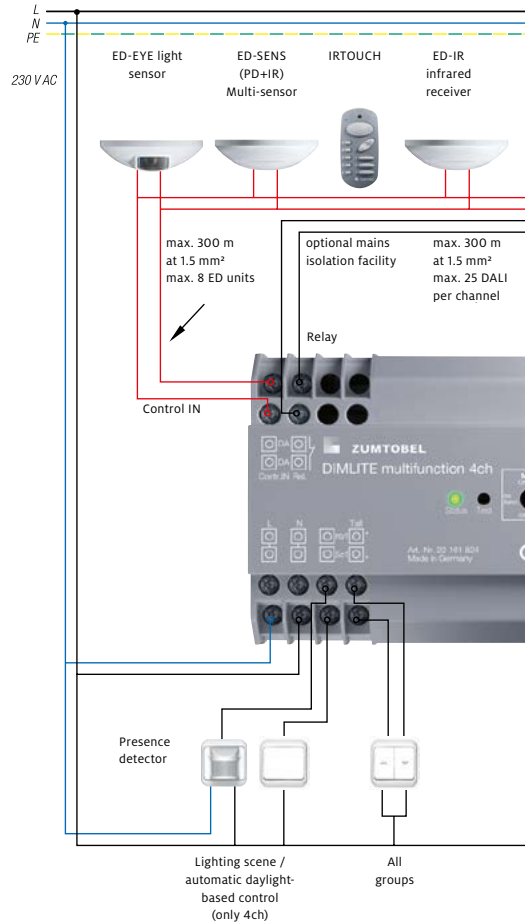

- L phase
- N neutral
- PE protective earth
- D control line



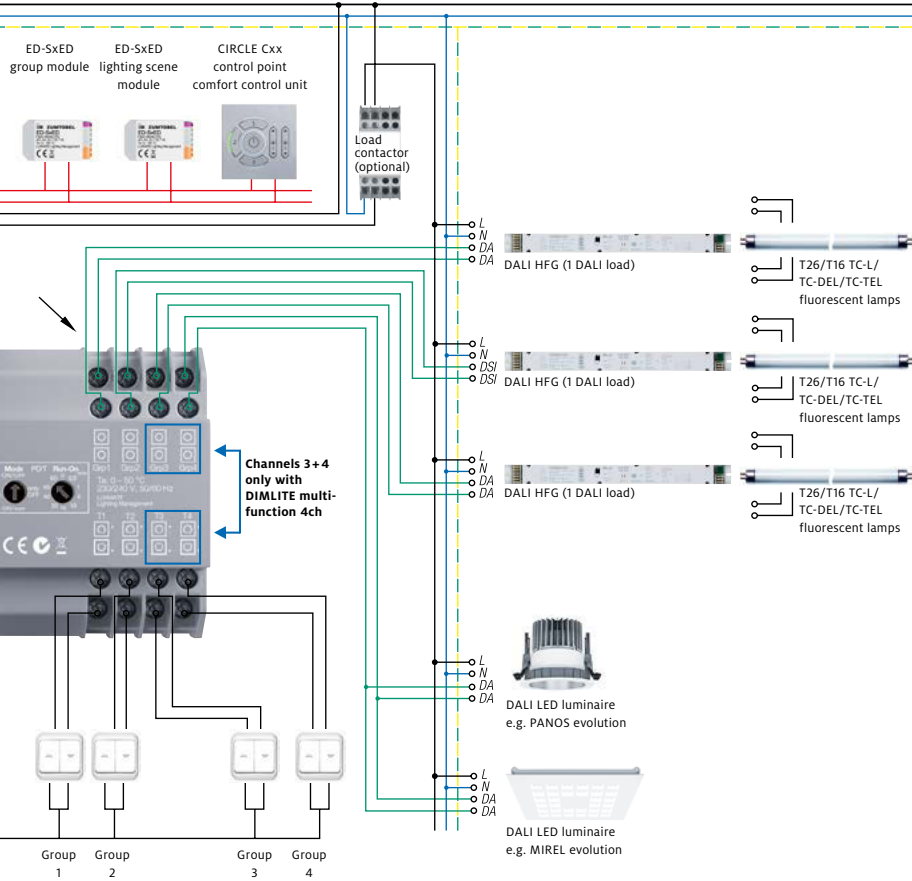

## LITECOM: General information

### Application

A single LITECOM controller is enough for small buildings or a single floor. If the system is expanded to a LITECOM infinity system, several existing controllers are linked with one another. The opposite way is also possible at any time. By removing them from the system, each controller can again be transferred to the self-sufficient LITECOM mode with 250 addresses.

### Technical data

#### System limit

250 addresses per LITECOM system

#### 3 x DALI incl. DALI voltage supply with 120 bus loads (240 mA) per DALI line

64 DALI units per DALI line

64 DALI ED units per DALI line

#### 1 x LM system bus (without bus power supply)

#### Test switch and status LED for each DALI chain

#### 1 x Ethernet 100 Mbits/s; RJ45 / CAT

#### Connection

Plug-in screw terminals for one-wire or fine-wire cables with cross-section ranging from 0.5 to 1.5 mm

#### Type of installation

DIN rail mounting (35 mm DIN rail acc. to EN 50022)

Space for only 9 units required

#### Permissible cable lengths

Cable cross-section	Max. cable length DALI Jointly with mains in the same cable		Max. cable length LM Jointly with mains in the same cable	
0.50 mm <sup>2</sup>	100 m	100 m	250 m	5 m
0.75 mm <sup>2</sup>	150 m	150 m	350 m	5 m
1.00 mm <sup>2</sup>	200 m	200 m	420 m	5 m
1.50 mm <sup>2</sup>	300 m	300 m	500 m	5 m

## LITECOM infinity: General information

### Application

The number of possible addresses adds up by linking several LITECOM controllers. A first generation LITECOM infinity system can comprise up to 2,500 addresses with up to 15 controllers and ultimately up to 100,000 addresses will be possible.

The system can thus be flexibly adjusted if the requirements in the building change.

### Technical data

#### System limit

250 addresses per LITECOM CCD

2,500 addresses with 15 controllers in the first LITECOM infinity generation,  
100,000 addresses in the final expansion stage.

#### 3 x DALI incl. DALI voltage supply with 120 bus loads (240 mA) per DALI line

64 DALI units per DALI line

64 DALI ED units per DALI line

#### 1 x LM system bus (without bus power supply)

#### Test switch and status LED for each DALI chain

#### 1 x Ethernet 100 Mbits/s; RJ45 / CAT

#### Connection

Plug-in screw terminals for one-wire or fine-wire cables  
with cross-section ranging from 0.5 to 1.5 mm

#### Type of installation

DIN rail mounting (35 mm DIN rail acc. to EN 50022)

Space for only 9 units required

#### Permissible cable lengths

Cable cross-section	Max. cable length DALI Jointly with mains in the same cable		Max. cable length LM Jointly with mains in the same cable	
0.50 mm <sup>2</sup>	100 m	100 m	250 m	5 m
0.75 mm <sup>2</sup>	150 m	150 m	350 m	5 m
1.00 mm <sup>2</sup>	200 m	200 m	420 m	5 m
1.50 mm <sup>2</sup>	300 m	300 m	500 m	5 m

## Lighting control systems

### Overview circuit for a LITECOM system

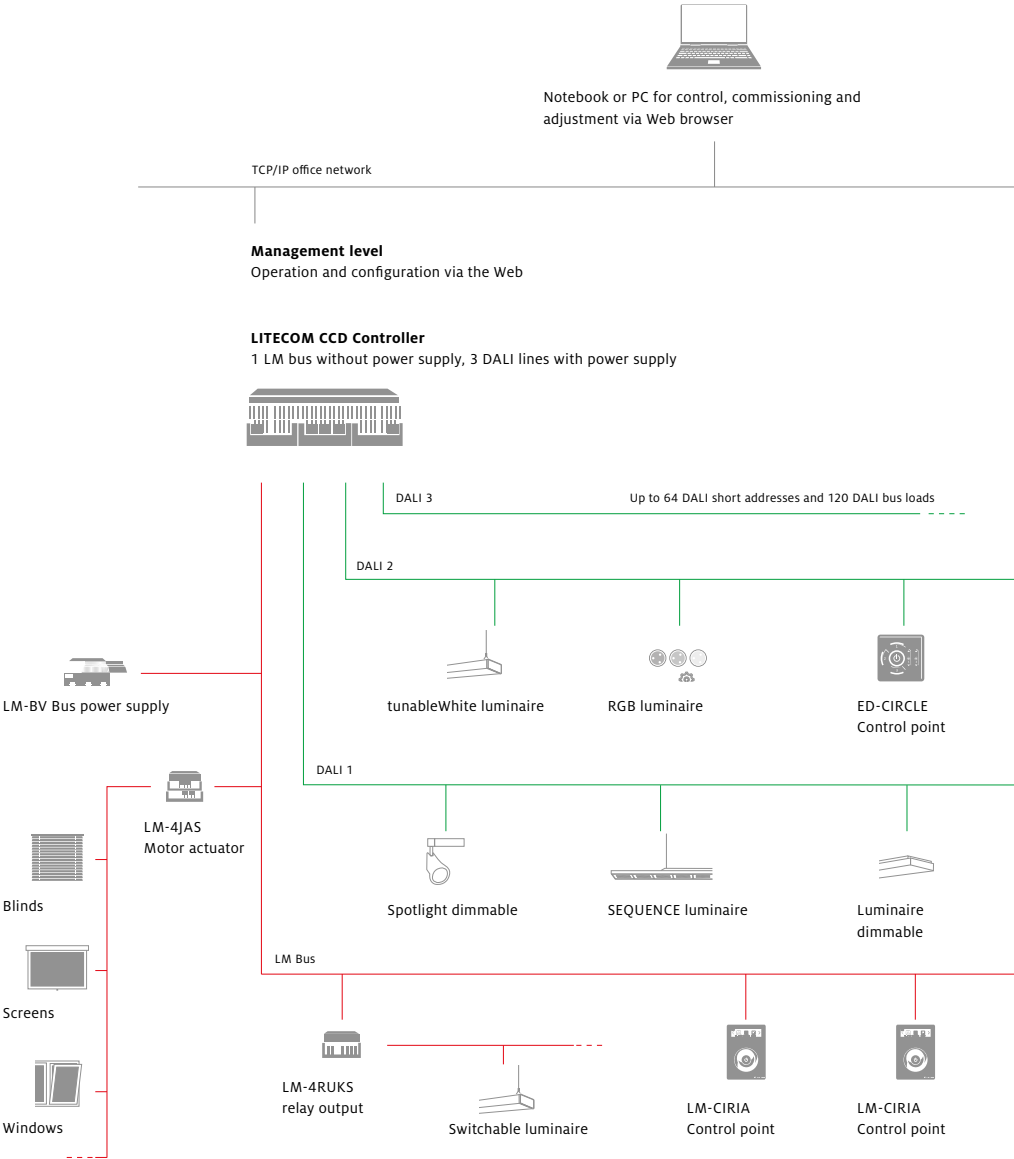

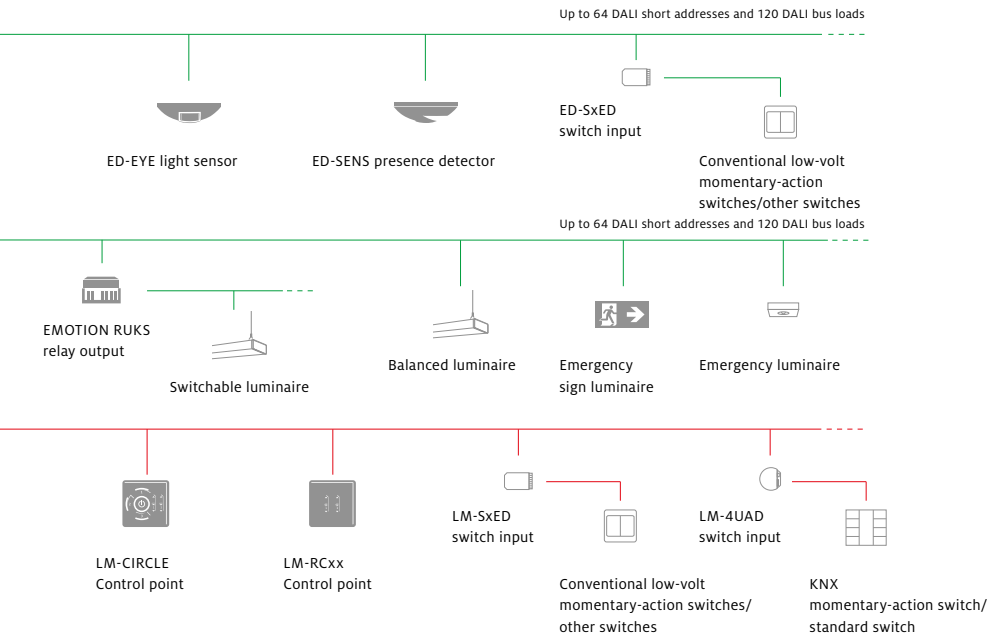
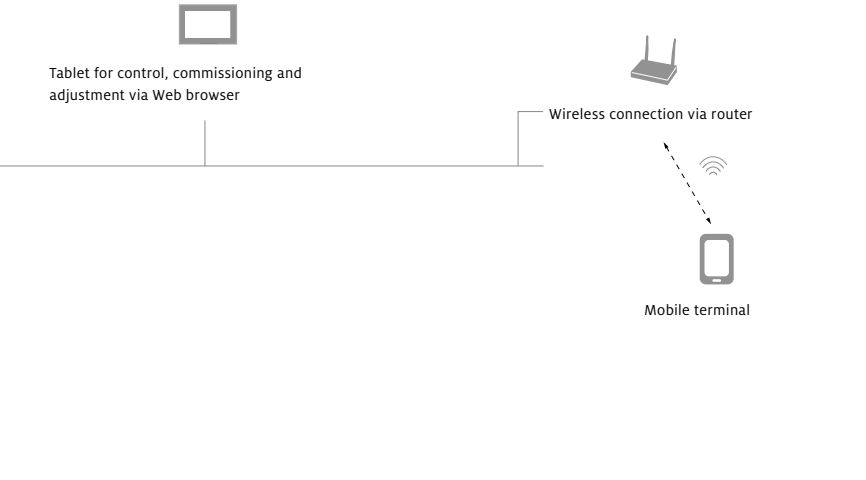

## Lighting control systems

### Overview circuit for a LITECOM infinity system

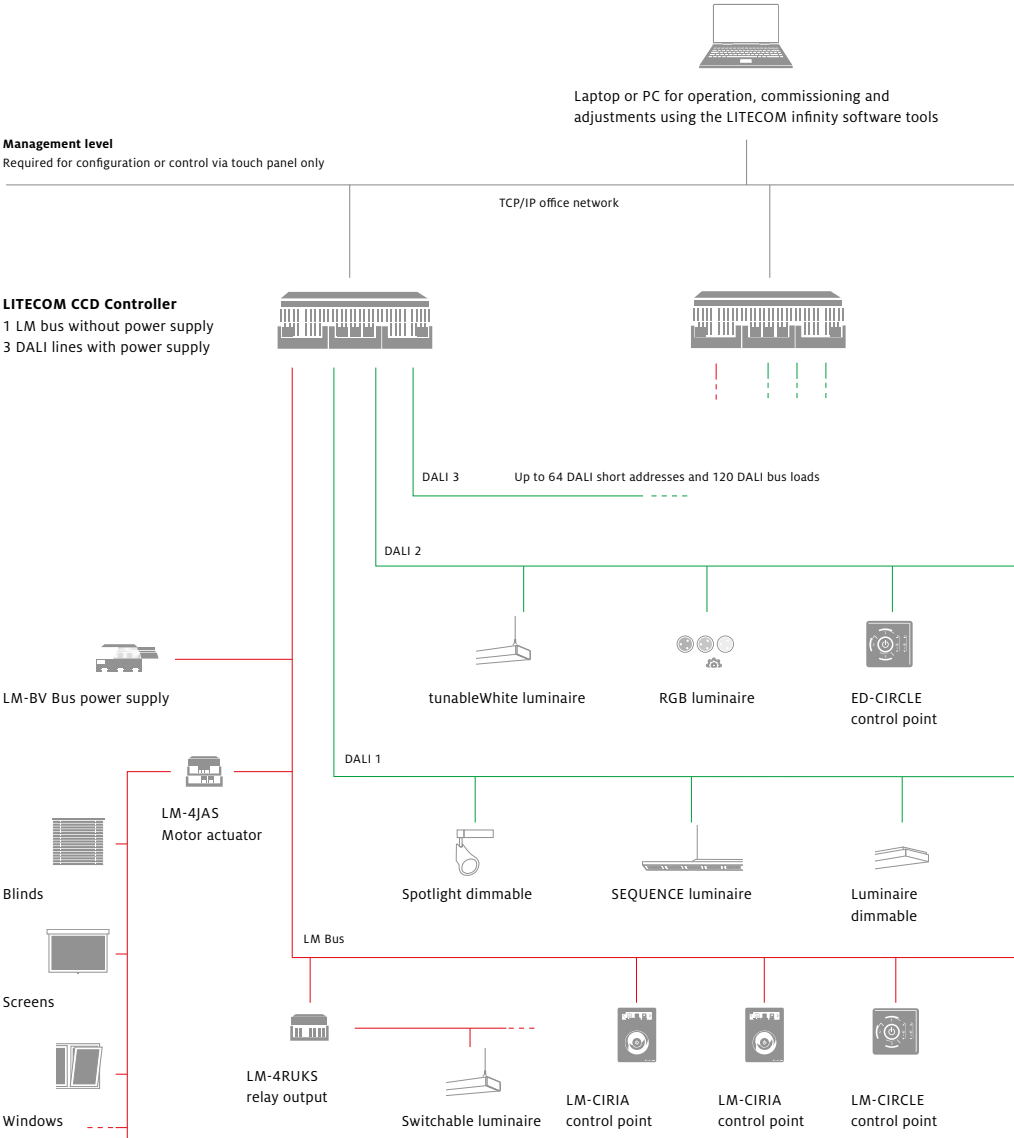

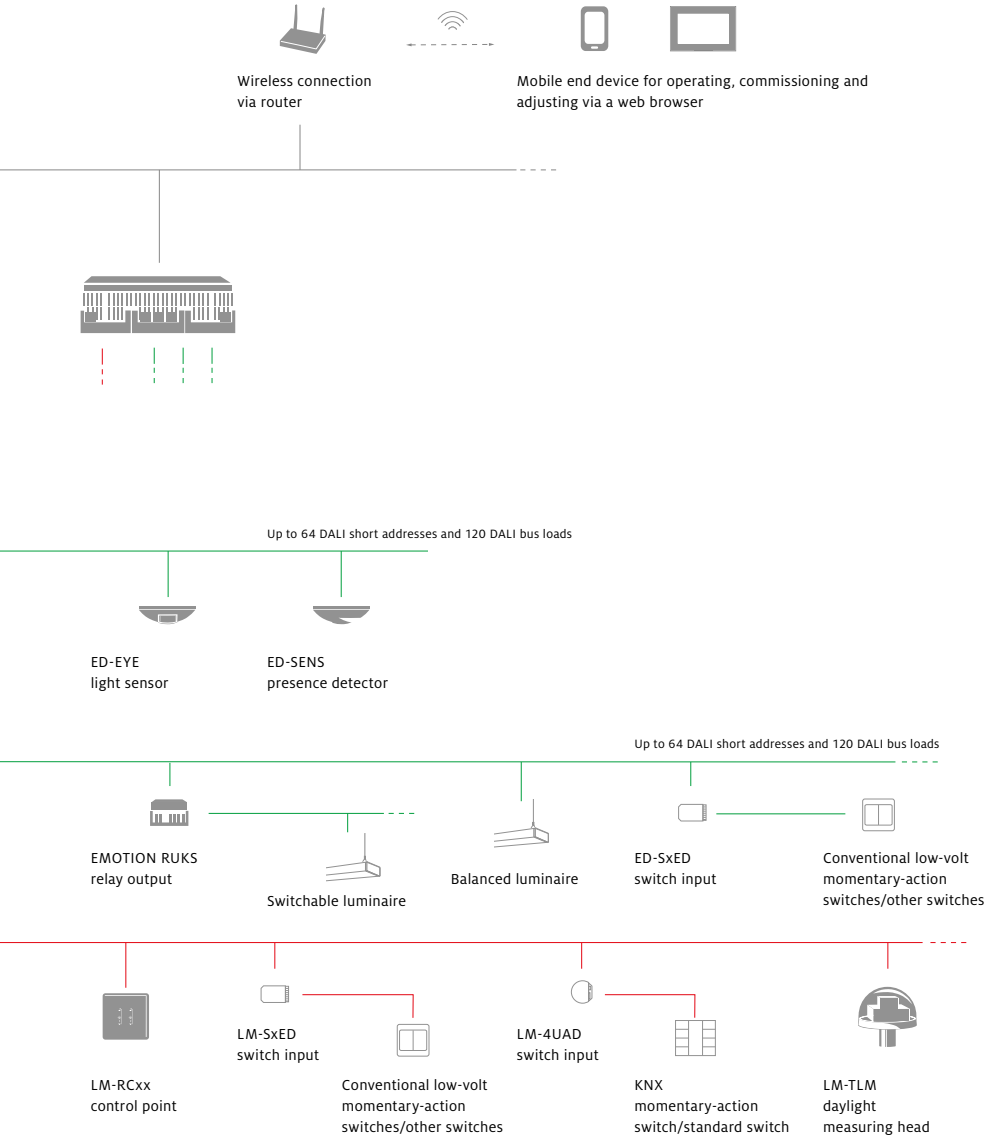

## LUXMATE LITENET: General information | Overview circuit

### Benefits

- Maximum flexibility: use of floor space (room and group addresses can be configured via software), flexibility of use (room profiles with basic functions for specific room utilisation), modular solution packages ranging from 500 to 10 000 luminaires
- Daylight-based blinds management with central daylight sensor
- Integration of the latest technologies: tunableWhite for LED colour temperature luminaires, enocean for wireless key switches, control via web browser (LITENET incontrol)
- Maximum of energy-saving options: daylight, presence, automated timing, Maintenance Control (constant light control)
- Software interfaces to building management system: OPC, BACnet

### Features

- Field technology is based on LUXMATE Professional with LUXMATE bus and optional integration of DALI and DSI control circuits
- Data exchange from PC (LITNET Flexis, LITENET, server) to gateway (LITENET netlink) via network technology (TCP/IP protocol)
- Gateway (LITENET netlink) allows easy integration of modules in the field area (3 DALI control circuits, 1 LUXMATE bus link; incl. power supply) (1 DALI load = 2 mA) per DALI control circuit



Sensor



Control points

LITENET flexis N2  
with server functional

TCP/IP

### LITENET economy

- up to 500 output addresses
- no server required
- LITENET flexisN2 without rotating parts (wear-free)
- optional LITENET incontrol operating software



Sensor



Control points

LITENET flexis N3  
with server functionality

TCP/IP

### LITENET compact

- up to 2000 output addresses
- no server required
- LITENET flexis N3 in 19" rack
- fail-safe thanks to RAID1
- optional LITENET incontrol operating software
- optional BACnet and OPC interfaces



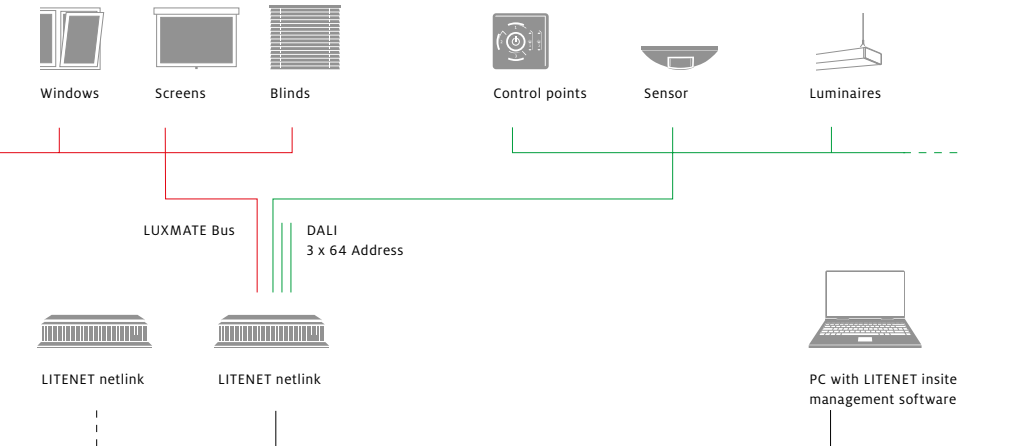
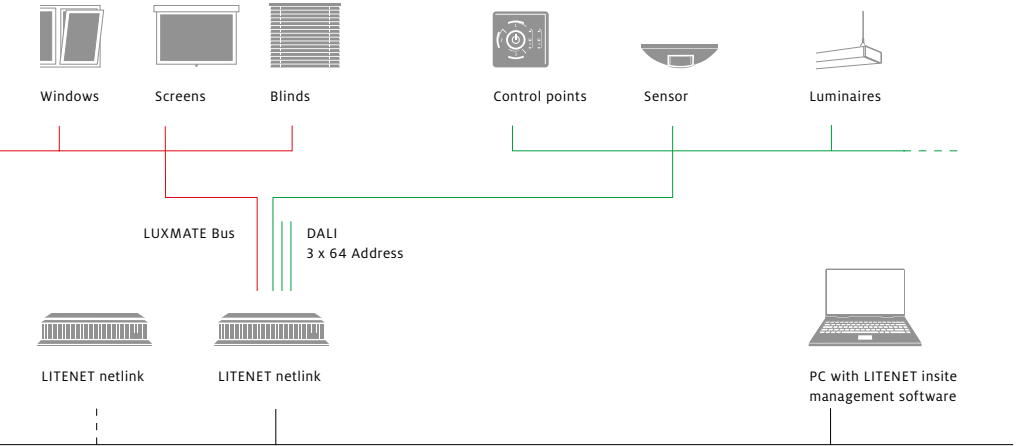

## Lighting control systems

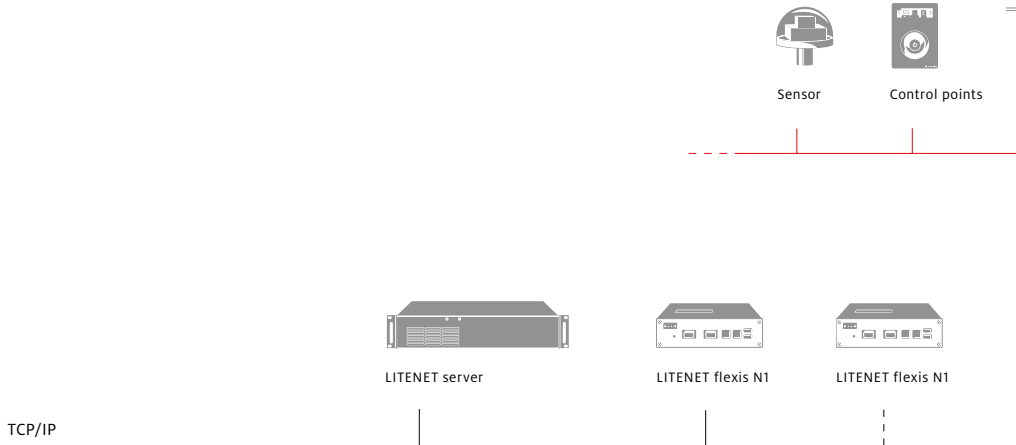

### LITENET flexibel

- up to 10 000 output addresses (or more upon request)
- can be cascaded as required
- LITENET flexis N1 installed in switch cabinet
- LITENET server extremely fail-safe thanks to RAID1
- optional LITENET incontrol operating software
- optional BACnet and OPC interfaces

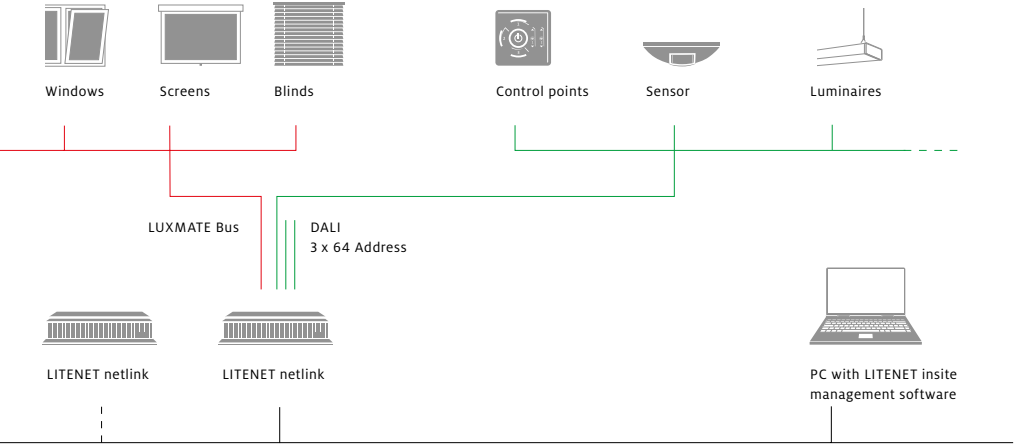

## Lighting control systems

### LUXMATE lighting management: Overview | Functions | Product ranges

Functions – Lighting	DIMLITE	LITECOM	LITENET
Manual switching and dimming	■	■	■
Presence-based switching	■	■	■
Daylight-based control	■	■	■
Synchronisation with daylight	■	■	■
Active lighting control		■	■
Time-based switching		■	■
Dynamic switching and dimming		■	■
Linked/conditional switching		■	■
Radio-controlled switching and dimming		■	■
Infrared remote control	■	■	■
Connection of regular switches and momentary-action switches	■	■	■
Call-up of static lighting scenes	■	■	■
Call-up of dynamic lighting scenes		■	■
Colour control		■	■
Colour temperature control		■	■
Switching actuators	■	■	■
Standard phase/reverse phase control	■	■	■
Control via DALI	■	■	■
Control via DSI	■	■	■
Control via DMX		■	■
Control via LUXMATE bus		■	■
Grouping of luminaires	■	■	■
Corridor function	■	■	■

<b>Functions – Blinds</b>	<b>LITECOM</b>	<b>LITENET</b>
Manual positioning	■	■
Presence-based positioning	■	■
Daylight-based positioning	■	■
Time-based positioning	■	■
Linked/conditional positioning	■	■
Security functions (wind, rain, frost)	■	■

### **Functions – Windows**

Manual opening/closing	■	■
Presence-based opening/closing	■	■
Time-based opening/closing	■	■
Linked/conditional opening/closing	■	■
Security functions (wind, rain, frost)	■	■

### **Central functions**

Fault indication	■	■
CAD plan-based visualisation		■
Failure reports via SMS, e-mail		■
Emergency lighting functions		■
Remote maintenance		■
Burning life management		■
Maintenance Control		■
Adaptation to room configurations	■	■

### **Functions – Integration with other building services**

TCP/IP text-based		■
BACnet		■
OPC		■

## Lighting control systems

### LUXMATE lighting management: Differentiation between DALI (EMOTION, LITENET) and DMX (E:cue)

	LITECOM	LUXMATE LITENET	E:cue Butler XT
<b>Lighting solution</b>			
architectural	■	■	(■)
emotional	■	-	■
communicative	-	-	(■)
<b>Speed</b>			
static/switching or dimming	■	■	-
slow/gentle transitions	■	■	■
fast changes in colour or brightness	-	-	■
video speed	-	-	-
<b>Effect</b>			
lighting	■	■	■
colour	■	■	■
diagram	-	-	(■)
text	-	-	■
video	-	-	(■)
<b>Miscellaneous</b>			
sensors	■	■	-
time-based control	■	■	-
dimming of luminaires	■	■	■
driving other motors	■	■	■
shows	■	■	■
playing back videos	-	-	(■)
addresses/channels	250	10 000	1024
addressing	via system	via system	on luminaire

- = applicable
- (■) = partly applicable
- = not applicable

## Control devices

### Functions overview

Function	DALI	DSI	1–10 V	Heavy-duty electr. ball.	Electr. ballast
Can be switched at zero power (digital control signal)	■	■			
Dimmability (via additional control lines)	■	■	■		
Dimming range (1 to 100%)	■	■	■		
DALI addressable (individual addressing, max. 64 addresses per control line)	■				
Can be configured (limitation of dimming levels, start level, fault level)	■				
Status reporting (dimming level, switching status, service readiness)	■				
Fault reporting (faulty lamp, device failure)	■				
Dimming automatically disabled in DC mode (dimming and switching signals are not accepted)	■				
Adjustable emergency lighting level (parameters ranging from 1 to 70%, factory setting: 70%)	■				
DC mode suitable for emergency lighting (DC mode in line with VDE 0108, operating voltage 176–280 V DC)	■	■	■	■	■
Critical operating conditions (ambient temperature: up to 70 °C, service life: 100 000 h)				■	





## Emergency lighting

---

### **ONLITE local –**

#### **emergency lighting system with separate battery supply**

SB 128 Controller	142
Control test system topology	144
ONLITE local emergency sets for separate battery supply	146

---

### **ONLITE central eBox –**

#### **central emergency power supply system**

System overview	148
SCM and OCM	150
SUB stations	152
System topology	154
Ballast/lumen factor table	156

---

### **ONLITE central CPS –**

#### **central battery system**

System overview	160
System topology	162
Ballast/lumen factor table	164

---

## ONLITE local – emergency lighting system with separate battery supply

### SB 128 Controller

Controlling an emergency lighting system is much more convenient and safe if it is networked via a DALI control line and an SB 128 Controller is connected.

The status of all the luminaires is displayed on the Controller, all notifications such as lamp faults or battery malfunctions are captured in a central location and logged in the test logbook. By doing this, the Controller takes on full responsibility for the emergency lighting system.



**Easy operation**

- Very easy commissioning and addressing of the entire emergency lighting installation – requires just one person
- Easy touch-screen operation
- Clearly laid-out, logical menu prompting
- Can monitor 128 luminaires, can be expanded to take 256 luminaires by fitting extenders

**Automatic tests and test logs**

- Test logbook with central logging of test results for at least three years
- Clock and calendar function for user-programmable test cycles
- Facility to manually trigger test functions on Controller

**High level of functionality**

- Display of all luminaires, configuration with description and addressing
- Mode can be selected individually for every ONLITE luminaire
- User-programmable signalling contacts and audible failure notification
- Installation can be disabled to allow servicing work

### ONLITE local – emergency lighting system with separate battery supply

## Control test system topology

Mains 230 V/50 HZ

L  
N  
PE

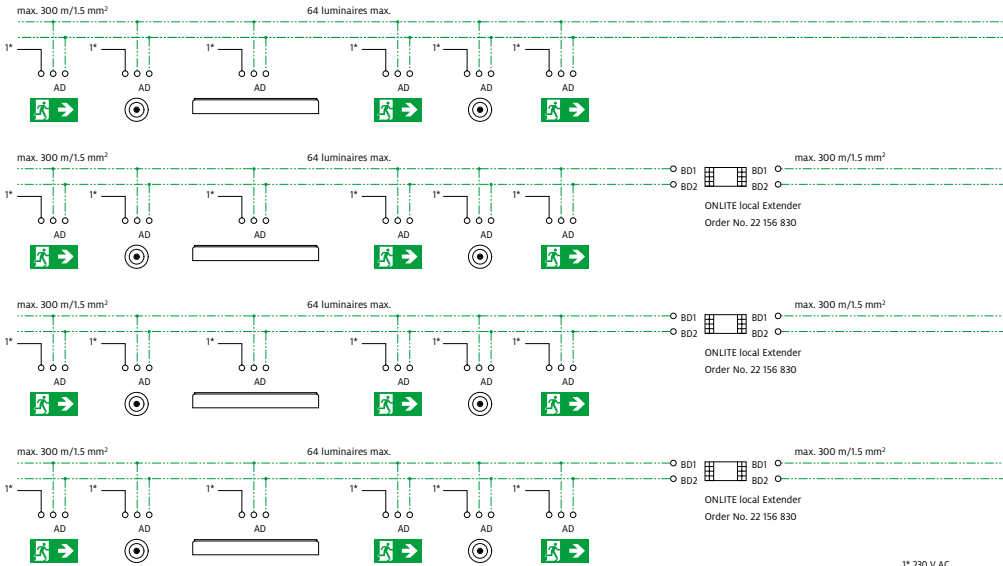
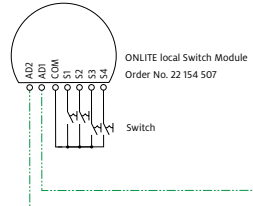

1\* 230 V AC  
Continuous phase



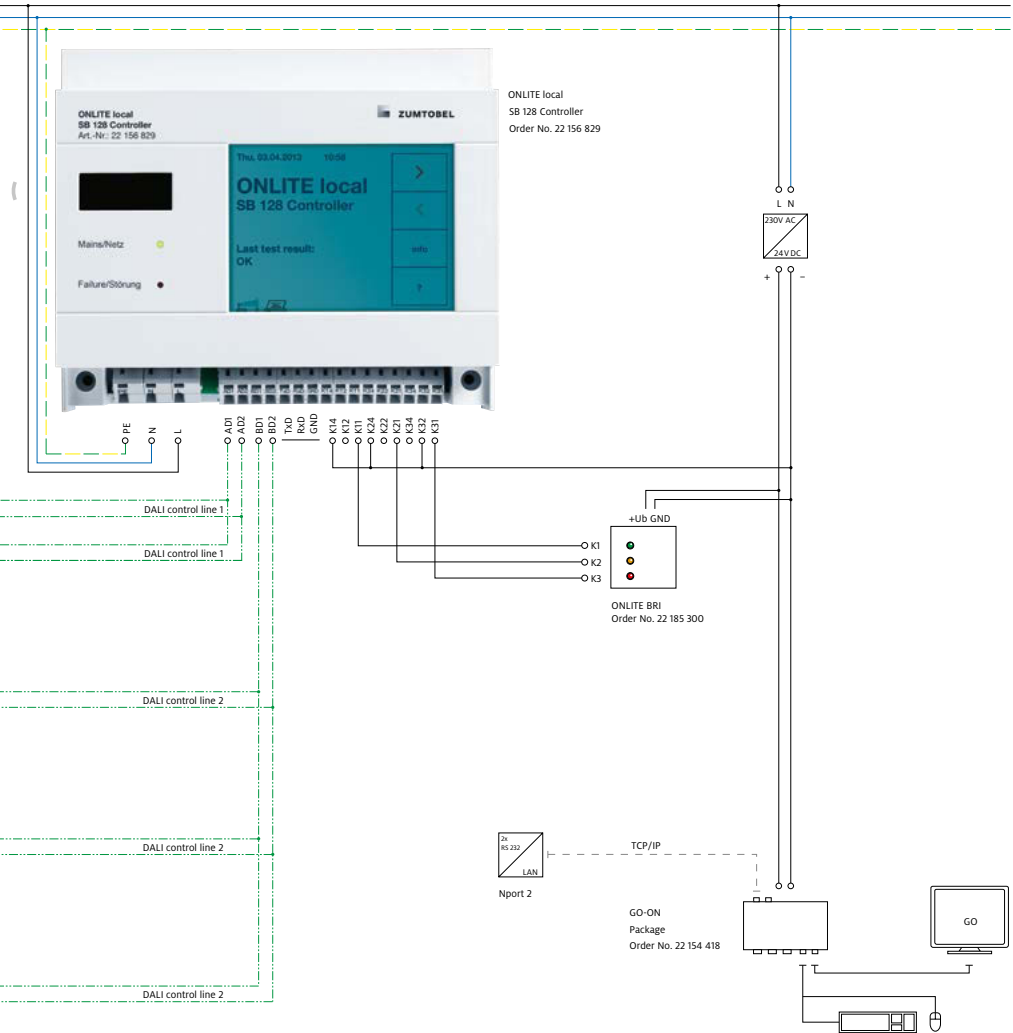

**ONLITE local – emergency lighting system with separate battery supply**



**ONLITE local emergency sets for separate battery supply**









Zumtobel’s luminaires are supplied ready to use with separate battery supply (emergency sets) for emergency lighting integrated into general lighting systems. Compliance to standards is guaranteed here compared to luminaires converted by the operator. The emergency sets are connected via DALI and an ONLITE local SB 128 Controller.

The emergency lighting consists of a control unit and battery. In contrast to the RESCLITE emergency set, the light source of the general lighting luminaire is used for emergency lighting. The ONLITE local emergency sets are available for backup of one or three hours.



**Overview ONLITE local emergency sets**

Symbol	Lamp	W	1 hour			3 hours			
			4 cells	5 cells	6 cells	4 cells	5 cells	6 cells	
	EM 14		EM 15	EM 16	EM 34	EM 35	EM 36		
	PRO EZ-3		PRO EZ-3	PRO EZ-3	PRO EZ-3	PRO EZ-3	PRO EZ-3		
	NT1-TR 14		NT1-TR 15	NT1-TR 16	NT3-TR 14	NT3-TR 15	NT3-TR 16		
Symbol	Lamp	W	BLF in emergency lighting mode in % for rated service life						
	TC-DD	10	33.0			33.0			
		16	24.0			24.0			
		21	17.0			17.0			
		28	14.0			14.0			
		38		7.5			7.5		
		55		5.2			5.2		
	TC-SEL	7	24.0			24.0			
		9	28.0			28.0			
		11	31.0			31.0			
	TC-DEL	10	30.0			30.0			
		13	26.0			26.0			
		18	17.0			17.0			
		26	14.4			14.4			

Symbol	Lamp	W	1 hour			3 hours		
			4 cells	5 cells	6 cells	4 cells	5 cells	6 cells
			EM 14 PRO EZ-3 NT1-TR 14	EM 15 PRO EZ-3 NT1-TR 15	EM 16 PRO EZ-3 NT1-TR 16	EM 34 PRO EZ-3 NT3-TR 14	EM 35 PRO EZ-3 NT3-TR 15	EM 36 PRO EZ-3 NT3-TR 16
			<b>BLF in emergency lighting mode in % for rated service life</b>					
	TC-TEL <sup>1</sup>	13	26.0			26.0		
		18 <sup>2</sup>	17.5/16.0	-/20.5 (GE)		17.5/16.0	-/20.5 (GE)	
		26 <sup>2</sup>	11.5/10.4	-/15.0	-/14.0	11.5/10.4	-/15.0	-/14.0
		32		14.0/5.0	-/8.0		14.0/5.6	-/8.0
		42			7.4/7.3			7.4/7.3
		57			5.1/5.2			5.1/5.2
	TC-F	18	18.0			18.0		
		24		21.0			21.0	
		36		13.0			13.0	
	TC-L	18	18.0			18.0		
		24		17.0			17.0	
		36		12.0			12.0	
		40		8.8			8.8	
		55			4.5			4.5
	T16 FH	14	22.0			22.0		
		21		17.0			17.0	
		28			14.0			14.0
		35			10.5			10.5
	T16 FQ	24	12.3			12.3		
		39			8.3			8.3
		49			6.4			6.4
		54			5.7			5.7
		80			4.7			4.7
	T16 C	22	11.5			11.5		
		40			6.0			6.0
		55			5.5			5.5
	T16	6	35.0			35.0		
		8	36.0			36.0		
		13	22.0			22.0		
	T26	15	16.5			16.5		
		18	16.5			16.5		
		30	9.5			9.5		
		36	8.0			8.0		
		38		10.5			10.5	
		58		6.5			6.5	
		70			3.7			3.7

<sup>1</sup> The first figure refers to non-amalgam lamps, the second figure to amalgam lamps (e.g. 14/9.5).

<sup>2</sup> For optimum operation of 26 W and 32 W TC lamps, in particular for lamps with an amalgam filling, we recommend the use of EM 36 PRO EZ-3 and EM 16 PRO EZ-3, respectively.

## ONLITE central eBox – central emergency power supply system

### System overview

ONLITE central eBox is perfectly adjusted, convenient and flexible: for each application, there is the right basic housing in a functional design. The main station is modular and still boasts a compact size for easy assembly. Extremely small SUB stations enable the devices to be used next to the final circuits in any recess, small as it may be. With the optional external modules at the system bus, the functions of each ONLITE central eBox system can be extended individually.

### Features

- Total output in emergency mode up to 2730 W for 1 hour emergency operation
- Total output in mains operation up to 5000 A
- 30 final circuits (OCM)
- 4 external SUB stations (SUB)
- 36 switch inputs (BSIM)
- 9 bus phase detectors (BPD)
- 1 remote display (BRI)
- Web browser interface for up to 10 000 luminaires and 100 systems



**eBox MS 1700  
Main station**

<b>Circuits (max. 20 luminaires)</b>	30 overall (6 internal, 24 external for SUB each with 3 double circuits)
<b>Maximum number of luminaires depending on the available battery capacity <sup>1)</sup></b>	600 overall 120 internal 120 per SUB external
<b>Mains connection</b>	3-pole (L / N / PE) 230 / 240 V ± 10% max. 5500 VA output in case of full capacity
<b>System Bus connection</b>	two core cable min. 2 x 0.75 mm <sup>2</sup>
<b>Mains operation</b> Total AC output power	5000 VA per SCM 1000 VA
<b>Emergency operation e.g. 1 h duration</b> Battery output DC total <sup>1)</sup>	2730 W at 24 Ah <sup>2)</sup> accommodated in the cabinet max. per SCM 750 W / 200 W per circuit



**eBox MS 1200  
Main station**

30 overall (6 internal,  
24 external for SUB each  
with 3 double circuits)

600 overall  
120 internal  
120 per SUB external

3-pole (L / N / PE)  
230 / 240 V ± 10%  
max. 5500 VA output in  
case of full capacity

two core cable  
min. 2 x 0.75 mm<sup>2</sup>

5000 VA per SCM  
1000 VA

1215 W bei 12 Ah<sup>2)</sup>  
accommodated in the cabinet  
max. per SCM  
750 W / 200 W per circuit

**eBox SUB E60  
Fireproof substation**

3 OCM modules with  
2 outputs circuits per  
module

120 pcs

5-pole (from the main  
station L / N / PE / B+ / B-)

two core cable to  
main station

1000 VA per SUB  
420 VA per OCM

max. 750 W per SUB<sup>3)</sup>  
max. 200 W per circuit

**eBox SUB IP65  
Substation**

3 OCM modules with  
2 outputs circuits per  
module

120 pcs

5-pole (from the main  
station L / N / PE / B+ / B-)

two core cable to  
main station

1000 VA per SUB  
420 VA per OCM

max. 750 W per SUB<sup>3)</sup>  
max. 200 W per circuit

**eBox SUB IP20  
Substation**

3 OCM modules with  
2 outputs circuits per  
module

120 pcs

5-pole (from the main  
station L / N / PE / B+ / B-)

two core cable to  
main station

1000 VA per SUB  
420 VA per OCM

max. 750 W per SUB<sup>3)</sup>  
max. 200 W circuit

**1) Battery power in W depending on nominal duration of battery-powered operation**

Battery type	System voltage	Max. DC system output including 25% ageing reserve as prescribed by the standard (EN 50 171 – 6.12.4)					
		8 h	5 h	3 h	2 h	1 h	0.5 h
ONLITE central eBox Accu PB / 12	[V]	8 h	5 h	3 h	2 h	1 h	0.5 h
7.2 Ah	216	131	178	274	381	656	1085
12.0 Ah	216	233	324	487	640	1215	1993
24.0 Ah	216	479	697	1040	1490	2730	3750

**2) Battery voltage 216 V nominal (189 – 249 V)**
**3) DC output power depends on the available battery capacity**

## ONLITE central eBox – central emergency power supply system

### ONLITE central eBox SCM

#### SCM Switch Connection Module

One ONLITE central eBox SCM is included in the standard scope of supply. If several SUB stations are used, one ONLITE central eBox SCM per SUB station must be ordered separately.

Output power AC	1000 VA
Output power DC	750 W
Fuses (6 x 32 mm)	3 x 8 A
Output voltage AC	230 / 240 V $\pm$ 10 %
Max. number of luminaires	120



**SCM**  
Switchover and fuse module

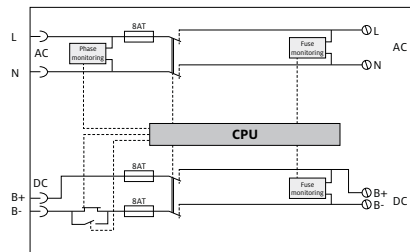

## ONLITE central eBox OCM

### OCM Output Circuit Modules

Up to three ONLITE central eBox OCMs per system can be used as an option. In this context, the different functions of the modules may also be mixed. Each circuit is separately protected by a 3.15 A 6 x 32 mm fuse. In the battery circuit, there is 2-pole fusing, in the mains network 1-pole fusing. The total output of the three double-circuit modules must not exceed 1000 VA and 750 W.

Output power per circuit AC	420 VA
Output power per circuit DC	200 W
Fuses (6 x 32 mm)	6 x 3,15 A
Output voltage AC	230 / 240 V $\pm$ 10 %
Output voltage DC (nominal)	216 V (189–249 V)

#### OCM-NDA

Double-circuit module  
DALI communication

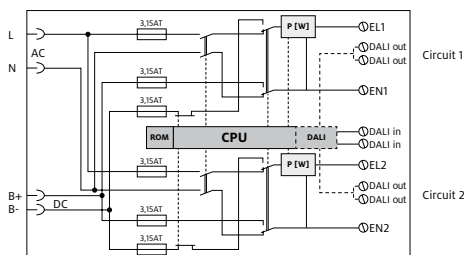

#### OCM-NSI

Double-circuit module  
Powerline communication

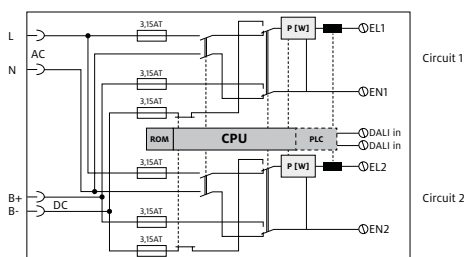

#### OCM-NPS

Double-circuit module  
with circuit monitoring

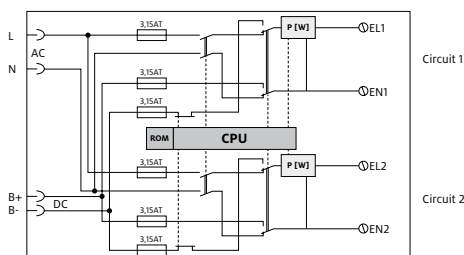

**ONLITE central eBox – central emergency power supply system**

**SUB stations**

**Cable entry to main station**

ONLITE central eBox MS 1200 or  
ONLITE central eBox MS 1700

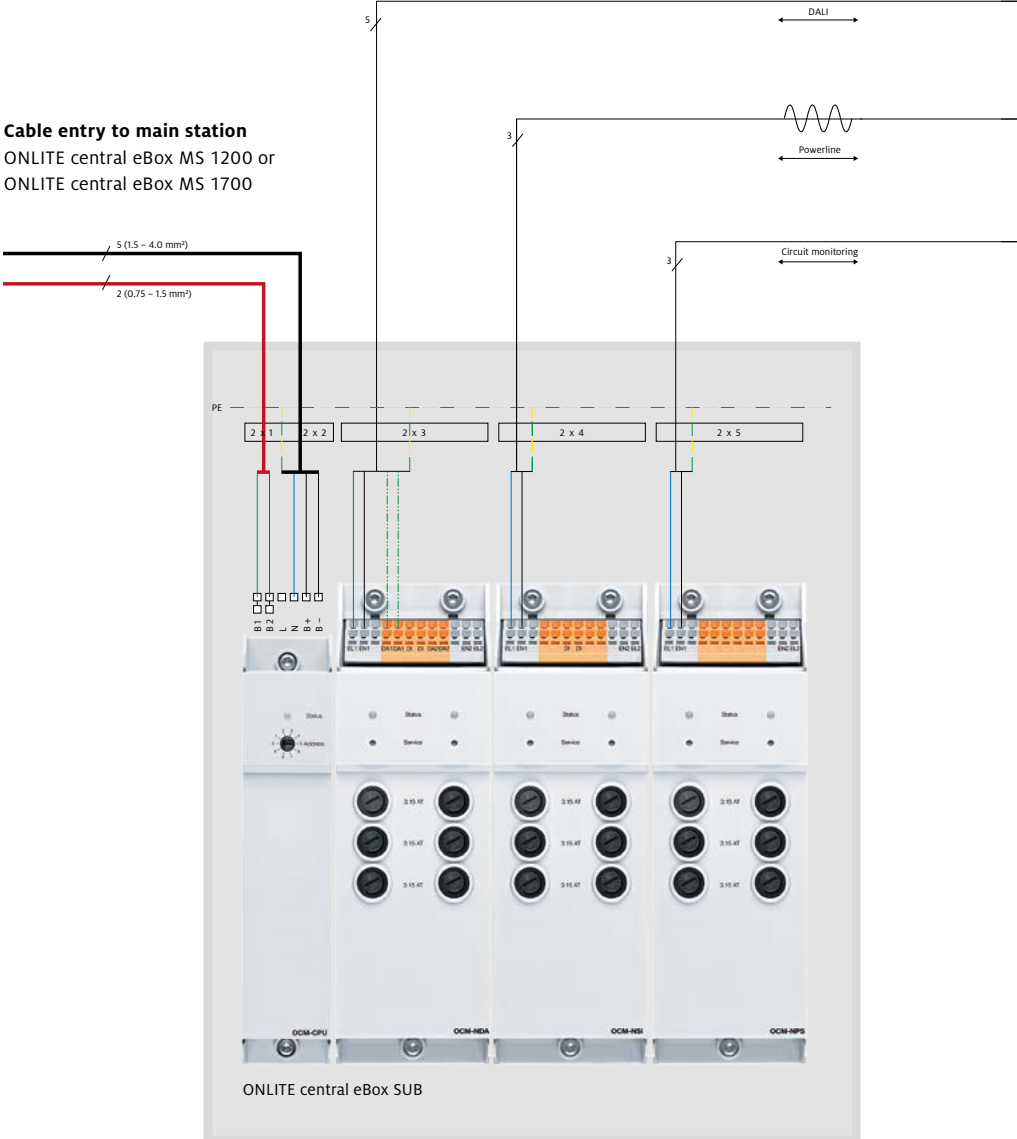

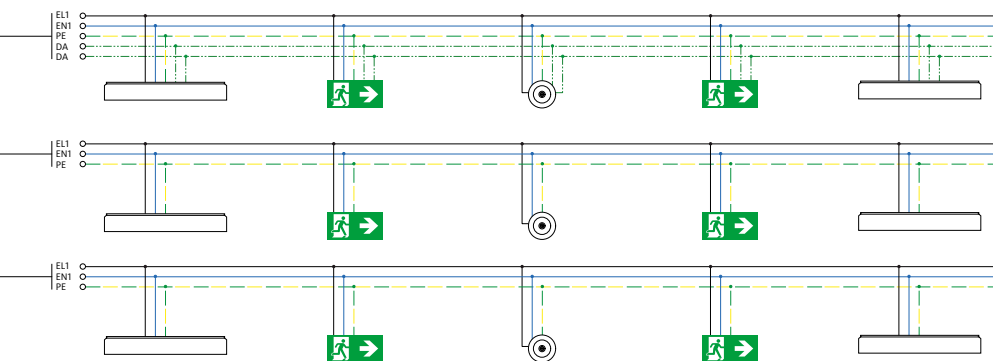

### Cable entry from substation to main station ONLITE central eBox

The 5-pole power cable must be installed in a FP cable up to the place of installation of the ONLITE central eBox SUB station of the respective fire compartment. If several fire compartments are supplied from the ONLITE central eBox SUB E60, the power cable must be installed in a fireproof manner up to the cabinet, and the final circuits up to the fire compartments to be supplied in each case.

The system bus may be executed in a linear manner or in a star topology. Fireproof installation is not required, since the monitoring of the bus is ensured through heartbeat control. If on account of an interruption or short-circuit, any logging data arrive late or not at all, AC emergency operation of all luminaires is activated at the final circuit.

### Three SUB stations are available

- *ONLITE central eBox SUB E60*  
Standard SUB station is used if final circuits in different fire compartments are served
- *ONLITE central eBox SUB E00*  
Standard SUB station in E00 IP20 to supply final circuits without crossing any fire compartment
- *ONLITE central eBox SUB IP65*  
Standard SUB station in E00 IP65 to supply final circuits without crossing any fire compartment for rough environments such as industry, car parks or underground parking

# ONLITE central eBox – central emergency power supply system

## System topology

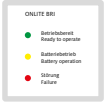

### ONLITE BRI remote display

The module is a remote display for the operational status of an emergency lighting system. This is required in every installation under EN 50172. The remote display is installed at a superordinate location within the building, in order to show the status of the system at any time.

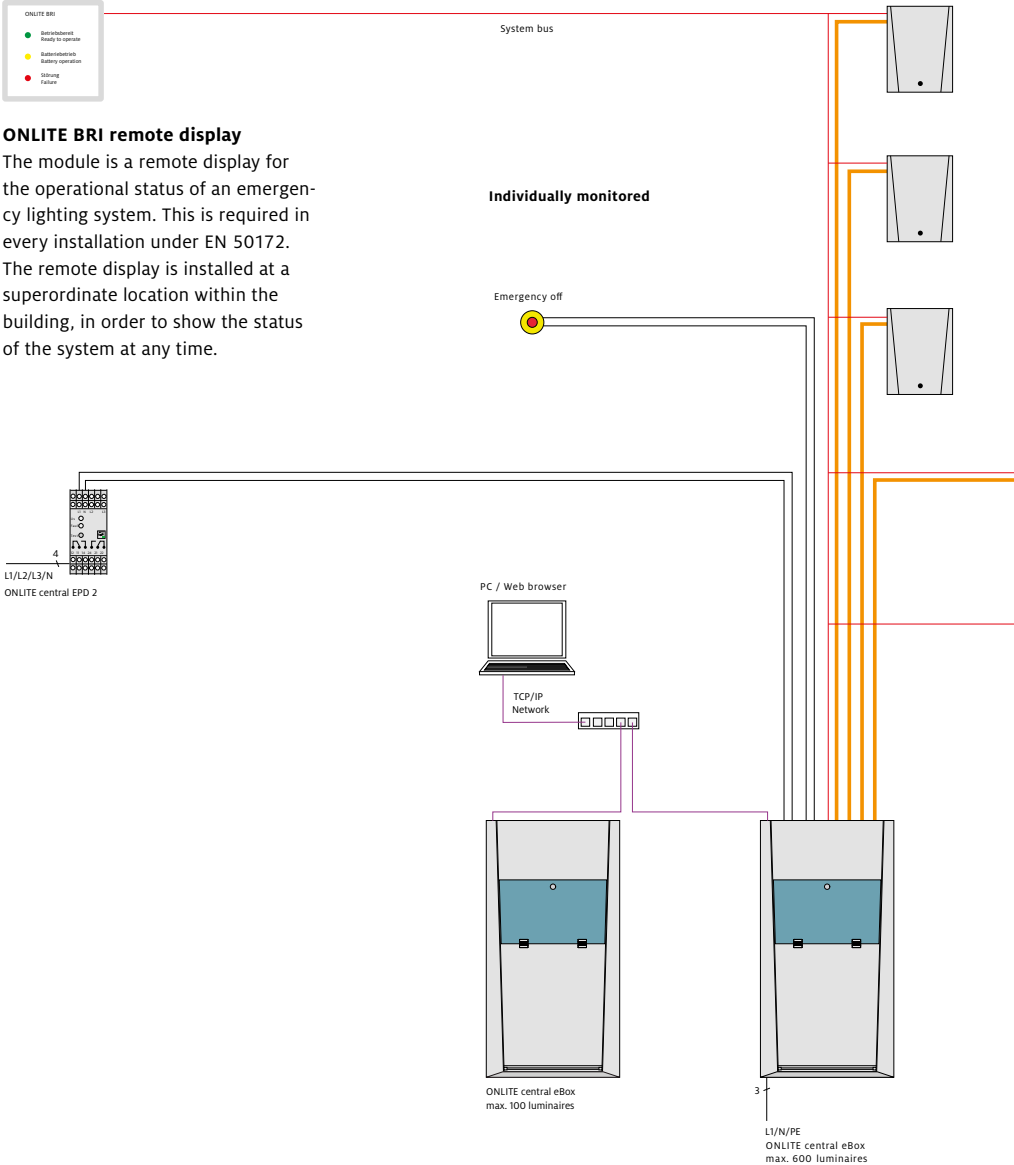

### Individually monitored DALI (NDA)

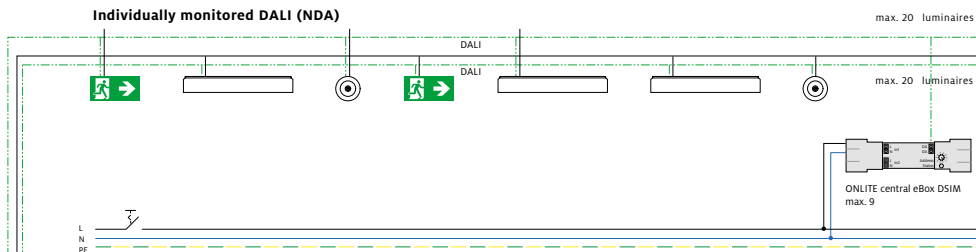

### Individually monitored Powerline (NSI)

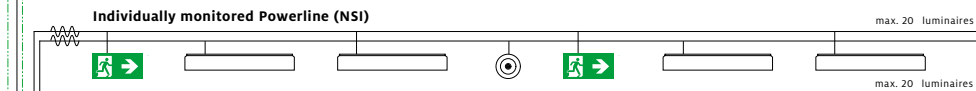

### Circuit monitored (NPS)

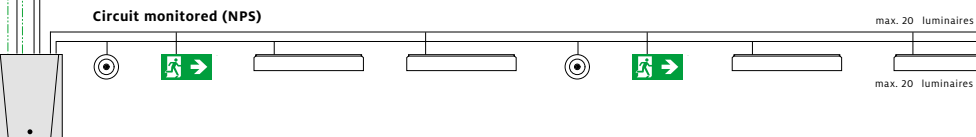

ONLITE central eBox  
SUB stations  
max. 4

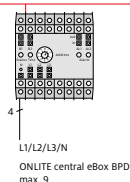
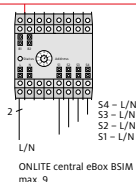

2  
System bus

### Status-LED\*



Green	System is ready for operation
Yellow	System in battery mode
Red	Too many faulty light sources in the system
Red, periodically on/ off every 0.5 s	error in the system
All, off	break-down of the system bus
All, periodically on/off every 0.5 s	error at the system bus or main station failure

\* Use with ONLITE central eBox



## ONLITE central eBox – central emergency power supply system

## Ballast/lumen factor table





Emergency lighting level	Light source	Wattage	AC power	DC [W]					
			[100%] 230 V/50 Hz [VA]	5%	10%	15%	20%	30%	40%
<b>LED</b>	LED		3.7		1.6	1.6	1.7	1.7	1.8
			3.7		1.7	1.8	1.8	1.9	2.0
			5.0		3.5	3.6	3.7	3.8	4.0
			5.0		3.4	3.5	3.6	3.7	3.8
			5.0		3.4	3.5	3.6	3.7	3.8
			6.0		4.4	4.5	4.6	4.7	4.8
			6.5		4.4	4.5	4.6	4.7	4.8
			11.0		8.1	8.4	8.7	9.1	9.4
			2.9		1.6	1.6	1.7	1.7	1.8
			6.0		2.0	2.2	2.4	2.8	3.2
			11.0		8.3	8.4	8.5	8.6	8.8
			5.0		3.5	3.6	3.7	3.8	4.0
			5.0		3.5	3.6	3.7	3.8	4.0
			5.4		1.5	1.7	1.9	2.3	2.6
			8.2		2.1	2.4	2.7	3.3	4.0
	T16	14 W	17.9	6.9	7.9	8.6	9.2	10.3	12.0
		2/14 W	33.0	11.1	13.4	15.2	16.3	18.8	21.4
		21 W	24.8	7.9	9.3	10.5	11.3	13.7	15.9
		2/21 W	47.2	12.9	15.7	17.8	20.0	24.5	28.7
		28 W	32.5	9.4	11.6	13.3	14.9	17.5	20.4
		2/28 W	61.8	15.4	19.3	22.9	26.3	31.6	37.6
		35 W	41.0	10.5	12.9	16.3	17.1	21.0	24.9
		2/35 W	77.4	16.6	21.6	26.0	29.6	37.7	45.2
		24 W	27.5	8.7	9.8	11.9	13.0	15.4	17.7
		2/24 W	51.7	14.8	18.1	21.2	24.4	28.9	33.4
		39 W	43.8	10.3	13.8	16.2	18.1	22.9	26.7
		2/39 W	86.5	17.5	23.7	28.9	34.0	42.5	51.4
		49 W	55.6	12.4	16.4	20.2	23.2	28.5	33.5
		2/49 W	110.3	20.6	28.2	35.9	41.6	52.5	62.8
		54 W	57.5	14.8	19.3	23.1	26.7	31.8	36.8
2/54 W	117.0	26.3	35.0	43.5	49.8	61.7	73.8		
80 W	90.9	17.3	24.7	30.9	36.3	45.0	53.9		
2/80 W	178.3	31.8	45.6	59.7	70.1	90.1	106.3		
	T26	1/18 W	19.8	7.1	8.1	9.2	10.3	11.6	13.6
		2/18 W	37.3	11.8	14.3	16.4	18.1	21.4	24.4
		1/36 W	37.6	9.0	11.1	13.2	15.3	19.0	22.5
		2/36 W	69.8	16.5	21.2	25.1	28.6	35.6	42.0
		1/58 W	54.3	12.1	16.1	19.5	22.3	27.6	32.7
		2/58 W	107.8	21.2	28.5	35.8	42.0	52.1	63.0



DC [W] 50%	DC [W] 60%	DC [W] 70%	DC [W] 100%	Control gear/luminaire
1.9		2.4	3.2	EMpowerX LED NSI / ARTSIGN C EW
2.1		2.4	3.2	EMpowerX LED NSI / ARTSIGN C ED
4.1		4.3	4.5	EMpowerX LED NSI / COMSIGN 150
4.0		4.2	4.5	EMpowerX LED NSI / CROSSIGN 110
4.0		4.2	4.5	EMpowerX LED NSI / CROSSIGN 110 ERI
5.0		5.2	5.5	EMpowerX LED NSI / CROSSIGN 160
5.0		5.2	5.5	EMpowerX LED NSI / CROSSIGN 160 ERI
9.7		10.1	10.5	EMpowerX LED NSI / CUBESIGN 210
1.9		2.1	2.4	EMpowerX LED NSI / ERGOSIGN LED
3.6		4.5	5.5	EMpowerX LED NSI / ECOSIGN LED IP 65
9.0		9.5	10.5	EMpowerX LED NSI / FREESIGN 300
4.1		4.3	4.5	EMpowerX LED NSI / PURESIGN 150
4.1		4.3	4.5	EMpowerX LED NSI / PURESIGN 150 ERI
3.0		3.8	4.9	EMpowerX LED NSI / RESCLITE C
4.6		5.8	7.7	EMpowerX LED NSI / SQUARESIGN 300
13.0	14.1	15.3	17.4	PCA 1 x 14/24 T5 EXCEL one4all Ip xitec II
23.7	25.6	28.1	32.6	PCA 2 x 14/24 T5 EXCEL one4all Ip xitec II
17.7	19.3	20.8	24.3	PCA 1 x 21/39 T5 EXCEL one4all Ip xitec II
32.3	35.4	39.1	46.7	PCA 2 x 21/39 T5 EXCEL one4all Ip xitec II
23.0	25.0	27.2	32.0	PCA 1 x 28/54 T5 EXCEL one4all Ip xitec II
42.6	46.9	51.4	61.4	PCA 2 x 28/54 T5 EXCEL one4all Ip xitec II
27.6	30.4	33.3	40.4	PCA 1 x 35/49/80 T5 EXCEL one4all Ip xitec II
51.1	56.7	62.6	77.1	PCA 2 x 35/49 T5 EXCEL one4all Ip xitec II
19.8	21.1	22.8	27.1	PCA 1 x 14/24 T5 EXCEL one4all Ip xitec II
37.6	41.1	44.7	51.5	PCA 2 x 14/24 T5 EXCEL one4all Ip xitec II
33.3	33.0	35.8	43.8	PCA 1 x 21/39 T5 EXCEL one4all Ip xitec II
58.1	64.5	71.6	86.3	PCA 2 x 21/39 T5 EXCEL one4all Ip xitec II
38.0	42.1	46.3	55.1	PCA 1 x 35/49/80 T5 EXCEL one4all Ip xitec II
73.0	80.9	89.6	110.2	PCA 2 x 35/49 T5 EXCEL one4all Ip xitec II
41.2	44.2	48.4	57.0	PCA 1 x 28/54 T5 EXCEL one4all Ip xitec II
82.2	90.5	99.8	117.1	PCA 2 x 28/54 T5 EXCEL one4all Ip xitec II
61.3	67.8	74.4	90.6	PCA 1 x 35/49/80 T5 EXCEL one4all Ip xitec II
122.1	134.5	147.9	178.0	PCA 2 x 80 T5 EXCEL one4all Ip xitec II
15.0	15.9	17.3	19.4	PCA 1 x 18 T8 EXCEL one4all Ip xitec II
27.2	29.3	32.2	37.0	PCA 2 x 18 T8 EXCEL one4all Ip xitec II
25.1	27.4	32.8	35.3	PCA 1 x 36 T8 EXCEL one4all Ip xitec II
48.1	53.2	58.6	69.6	PCA 2 x 36 T8 EXCEL one4all Ip xitec II
36.9	41.1	44.6	54.1	PCA 1 x 58 T8 EXCEL one4all Ip xitec II
72.4	79.4	88.0	108.5	PCA 2 x 58 T8 EXCEL one4all Ip xitec II

## ONLITE central eBox – central emergency power supply system

## Ballast/lumen factor table

Emergency lighting level	Light source	Wattage	AC power [100%] 230 V/50 Hz						
			[VA]	DC [W] 5%	DC [W] 10%	DC [W] 15%	DC [W] 20%	DC [W] 30%	DC [W] 40%
	TC-L/F	1/18 W	18.0	7.9	8.2	9.7	10.7	11.6	12.9
		2/18 W	33.4	13.1	15.1	16.0	18.0	20.9	24.0
		1/24 W	24.9	8.4	10.1	11.5	12.2	14.4	16.5
		2/24 W	47.3	13.0	16.5	19.6	21.9	26.4	30.3
		1/36 W	36.4	10.3	12.4	14.9	16.4	19.7	23.2
		2/36 W	71.0	16.1	21.2	25.8	30.0	36.6	43.6
		1/40 W	46.0	8.8	12.0	14.9	17.4	22.2	26.6
		2/40 W	88.7	17.3	23.4	29.4	34.6	43.8	53.1
	TC-S/E	1/11 W	15.7	6.4	7.5	8.2	8.6	9.8	11.2
		2/11 W	27.6	8.7	10.4	11.7	13.1	15.3	17.3
	TC-D/E	1/13 W	15.5	6.4	7.5	7.8	8.5	10.2	11.2
		2/13 W	28.2	9.1	11.0	12.6	14.0	16.3	18.1
	TC-D/T	1/18 W	20.7	7.0	8.5	10.0	11.1	12.8	14.2
		2/18 W	38.9	11.1	13.6	16.4	18.1	22.2	25.3
		1/26 W	28.4	8.7	10.5	12.4	13.6	15.9	18.5
		2/26 W	53.1	14.1	17.4	21.0	23.7	28.5	33.0
	TC-T/E	1/32 W	33.6	9.4	12.1	14.1	16.0	19.0	22.3
		2/32 W	58.4	14.5	19.7	24.5	28.1	34.4	40.0
		1/42 W	40.7	10.4	13.0	15.6	18.5	22.9	27.7
		2/42 W	75.4	15.4	21.8	27.4	31.8	40.5	48.5
	TC-DD	1/28 W	31.0	8.9	10.6	12.6	13.9	16.6	18.9

DC [W] 50%	DC [W] 60%	DC [W] 70%	DC [W] 100%	Control gear/luminaire
14.2	14.9	15.7	17.7	PCA 1 x 18/24 TCL EXCEL one4all c xitec II
25.9	28.0	30.6	33.1	PCA 2 x 18/24 TCL EXCEL one4all c xitec II
18.2	19.3	20.8	24.6	PCA 1 x 18/24 TCL EXCEL one4all c xitec II
34.0	37.0	40.6	47.1	PCA 2 x 18/24 TCL EXCEL one4all c xitec II
25.5	27.7	30.0	36.3	PCA 1 x 21/39 T5 EXCEL one4all lp xitec II
48.6	53.8	59.5	70.9	PCA 2 x 21/39 T5 EXCEL one4all lp xitec II
30.5	33.6	37.0	46.1	PCA 1 x 21/39 T5 EXCEL one4all lp xitec II
60.4	67.1	74.5	89.0	PCA 2 x 21/39 T5 EXCEL one4all lp xitec II
44.9	49.0	53.7	64.4	PCA 1 x 35/49/80 T5 EXCEL one4all lp xitec II
86.1	94.8	105.2	125.4	PCA 2 x 80 T5 EXCEL one4all lp xitec II
12.4	13.0	14.4	15.3	PCA 1 x 11/13 TC EXCEL one4all xitec II
19.6	21.1	23.0	27.0	PCA 2 x 11/13 TC EXCEL one4all xitec II
11.9	13.1	13.9	15.0	PCA 1 x 11/13 TC EXCEL one4all xitec II
21.0	21.0	24.1	27.8	PCA 2 x 11/13 TC EXCEL one4all xitec II
15.6	16.8	18.0	20.2	PCA 1 x 18 TC EXCEL one4all xitec II
28.2	30.7	33.5	37.5	PCA 2 x 18 TC EXCEL one4all xitec II
20.4	22.2	24.0	27.7	PCA 1 x 26-57 TC EXCEL one4all xitec II
37.4	40.7	45.0	52.7	PCA 2 x 26/32/42 TC EXCEL one4all xitec II
25.0	26.4	29.0	32.4	PCA 1 x 26-57 TC EXCEL one4all xitec II
44.6	47.9	51.7	58.3	PCA 2 x 26/32/42 TC EXCEL one4all xitec II
31.4	35.0	37.1	44.9	PCA 1 x 26-57 TC EXCEL one4all xitec II
55.6	60.1	65.2	74.5	PCA 2 x 26/32/42 TC EXCEL one4all xitec II
21.6	23.6	25.8	30.5	PCA 1 x 28 TC-DD EXCEL one4all xitec II

## ONLITE central CPS – central battery system

### System overview

Every ONLITE central CPS offers full functionality in order to comprehensively meet the requirements placed on a central battery system using as few components as possible.

No additional software or modules are needed. There is no need to fit any separate components in the luminaire because every DALI luminaire can be used as an emergency luminaire which can be individually moni-

tored and controlled. This also reduces effort on commissioning, inspecting and maintaining the system.

A large removable Touch PC is the core of the system. For example, it enables straightforward commissioning by one person or neatly laid out, easily manageable visualisation of the system's status.

### Features

- Power in emergency mode 1–30 kW
- Up to 300 circuits, each for 20 emergency luminaires \*
- Up to 12 external substations per main station (CPS H)
- Mixed operation within one circuit is possible
- Up to 240 (optional) freely assignable switching inputs
- Web browser-based user interface

---

### Circuits (up to 20 luminaires)

#### Maximum number of luminaires

#### Mains connection

---

#### Mains operation

Total AC output power

Max. AC output power per circuit

AC output power per 20 circuits (per UVS)

---

#### Emergency mode

Total DC output power

Max. DC output power per circuit

DC output power per 20 circuits (per UVS)

Standby operating time 1–8 h

---



CPS K  
Compact station



CPS H  
Main station



CPS U E60  
Fire-resistant  
substation



CPS U E00  
Substation

1) Up to 40 internal + 20 external  
2) Up to 20 internal + 140 external

1) 1200 pcs  
2) 3200 pcs

5-pole 3 x 400 V

up to 60 internal + 240 external

6000 pcs

5-pole 3 x 400 V

20

20

7–30 kVA

1300 VA

4700 VA

30 kVA

1300 VA

4700 VA

4700 VA

1300 VA

4700 VA

4700 VA

1300 VA

4700 VA

7.6 kW [1 h]\* 3.3 kW [3 h]\*

1300 W

4700 W

18 x 12 V / 7–75 Ah  
accommodated in  
combined cabinet

22.7 kW [1 h]\* 10 kW [3 h]\*

1300 W

4700 W

18 x 12 V to 200 Ah  
accommodated in separate  
battery cabinet or battery rack

\* Including 25% reserve capacity (battery ageing)

ONLITE central CPS – central battery system

System topology

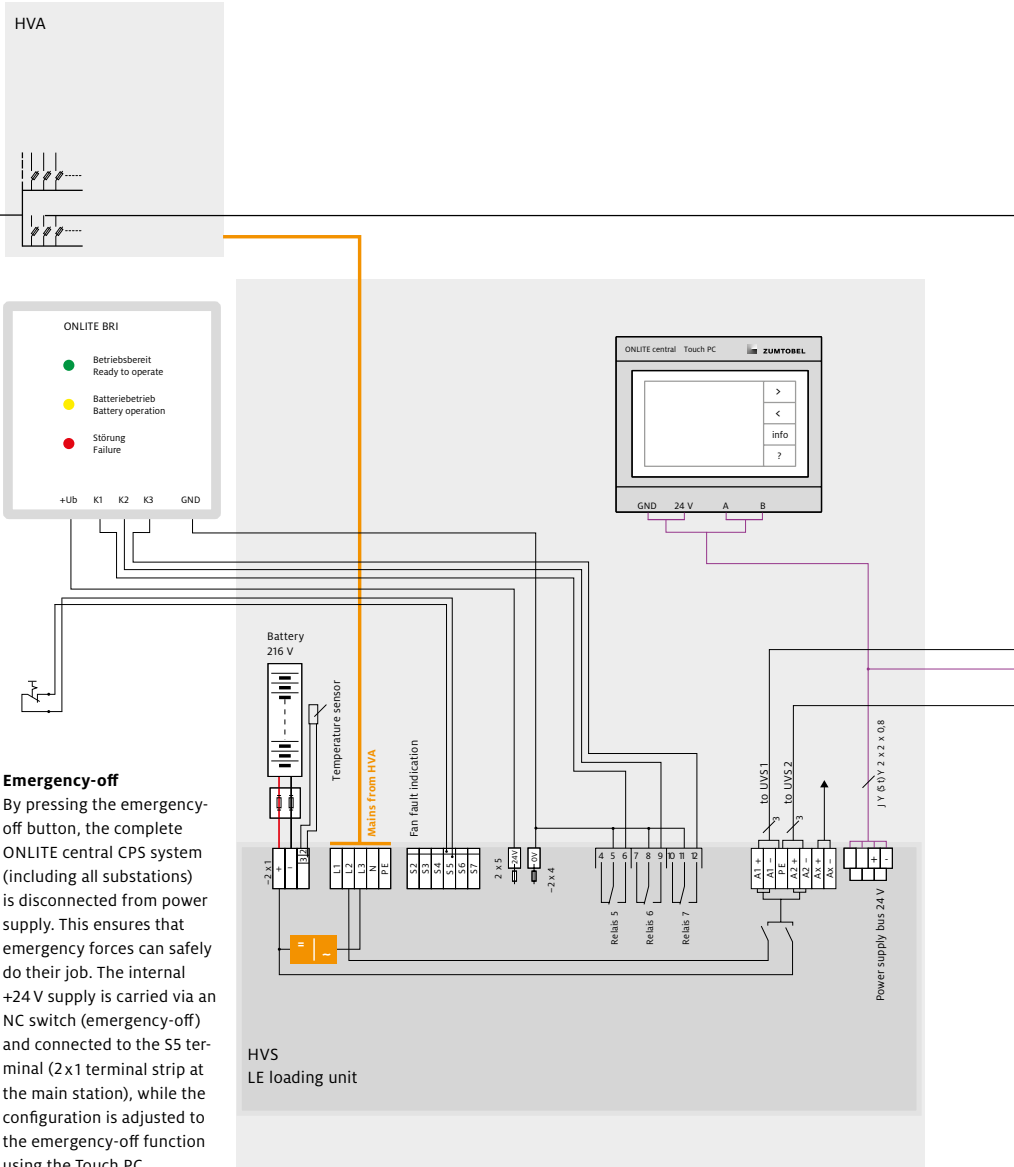

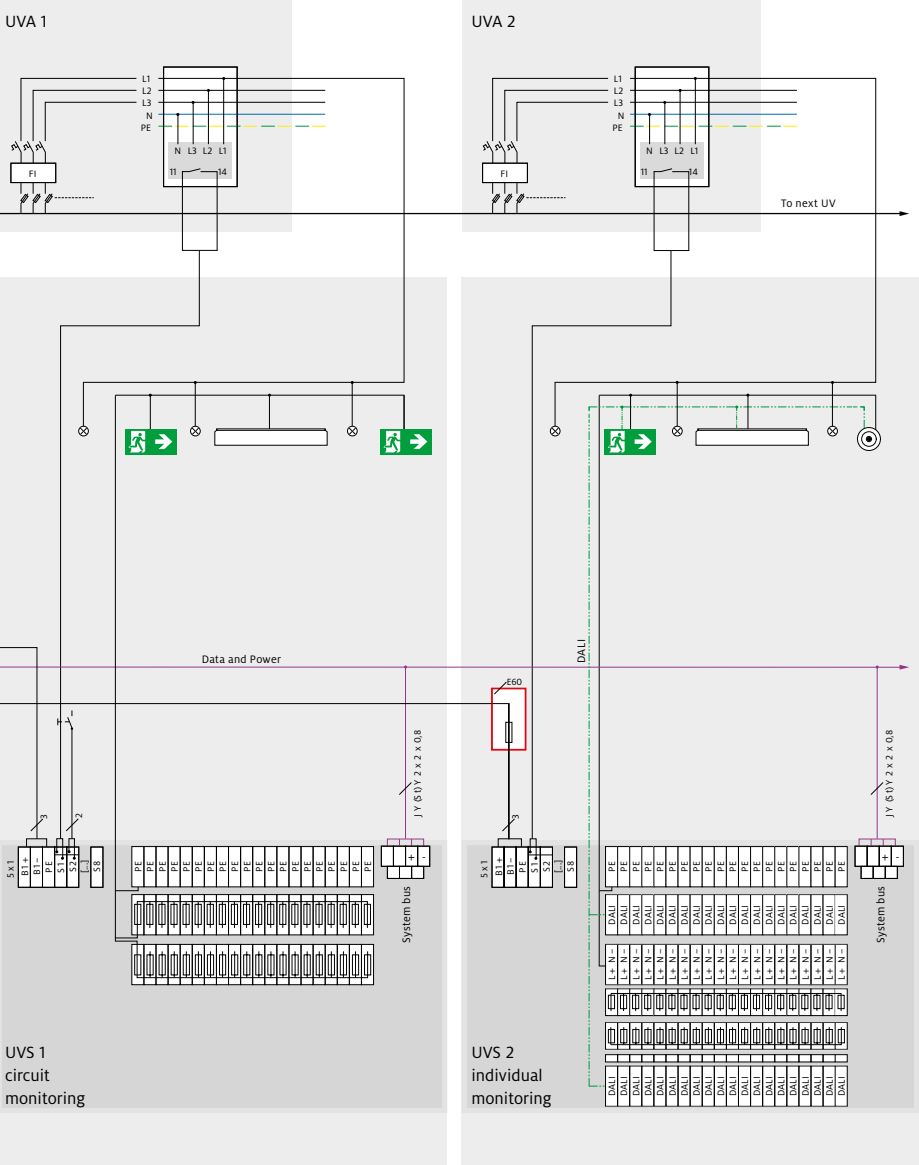

**Emergency-off**

By pressing the emergency-off button, the complete ONLITE central CPS system (including all substations) is disconnected from power supply. This ensures that emergency forces can safely do their job. The internal +24 V supply is carried via an NC switch (emergency-off) and connected to the S5 terminal (2x1 terminal strip at the main station), while the configuration is adjusted to the emergency-off function using the Touch PC.



## ONLITE central CPS – central battery system

## Ballast/lumen factor table





Emergency lighting level	Light source	Wattage	AC power	DC [W]					
			[100%] 230 V/50 Hz [VA]	5%	10%	15%	20%	30%	40%
<b>LED</b>	LED		3.2		1.6	1.6	1.7	1.7	1.8
			3.2		1.7	1.8	1.8	1.9	2.0
			4.5		3.5	3.6	3.7	3.8	4.0
			4.5		3.4	3.5	3.6	3.7	3.8
			4.5		3.4	3.5	3.6	3.7	3.8
			5.5		4.4	4.5	4.6	4.7	4.8
			6.0		4.4	4.5	4.6	4.7	4.8
			10.5		8.1	8.4	8.7	9.1	9.4
			2.4		1.6	1.6	1.7	1.7	1.8
			5.5		2.0	2.2	2.4	2.8	3.2
			10.5		8.3	8.4	8.5	8.6	8.8
			4.5		3.5	3.6	3.7	3.8	4.0
			4.5		3.5	3.6	3.7	3.8	4.0
			4.9		1.5	1.7	1.9	2.3	2.6
			7.7		2.1	2.4	2.7	3.3	4.0
	T16	14 W	17.4	6.9	7.9	8.6	9.2	10.3	12.0
		2/14 W	32.5	11.1	13.4	15.2	16.3	18.8	21.4
		21 W	24.3	7.9	9.3	10.5	11.3	13.7	15.9
		2/21 W	46.7	12.9	15.7	17.8	20.0	24.5	28.7
		28 W	32.0	9.4	11.6	13.3	14.9	17.5	20.4
		2/28 W	61.3	15.4	19.3	22.9	26.3	31.6	37.6
		35 W	40.5	10.5	12.9	16.3	17.1	21.0	24.9
		2/35 W	76.9	16.6	21.6	26.0	29.6	37.7	45.2
		24 W	27.0	8.7	9.8	11.9	13.0	15.4	17.7
		2/24 W	51.2	14.8	18.1	21.2	24.4	28.9	33.4
		39 W	43.3	10.3	13.8	16.2	18.1	22.9	26.7
		2/39 W	86.0	17.5	23.7	28.9	34.0	42.5	51.4
		49 W	55.1	12.4	16.4	20.2	23.2	28.5	33.5
		2/49 W	109.8	20.6	28.2	35.9	41.6	52.5	62.8
		54 W	57.0	14.8	19.3	23.1	26.7	31.8	36.8
2/54 W	116.5	26.3	35.0	43.5	49.8	61.7	73.8		
80 W	90.4	17.3	24.7	30.9	36.3	45.0	53.9		
2/80 W	177.8	31.8	45.6	59.7	70.1	90.1	106.3		
	T26	1/18 W	19.3	7.1	8.1	9.2	10.3	11.6	13.6
		2/18 W	36.8	11.8	14.3	16.4	18.1	21.4	24.4
		1/36 W	37.1	9.0	11.1	13.2	15.3	19.0	22.5
		2/36 W	69.3	16.5	21.2	25.1	28.6	35.6	42.0
		1/58 W	53.8	12.1	16.1	19.5	22.3	27.6	32.7
		2/58 W	107.3	21.2	28.5	35.8	42.0	52.1	63.0



DC [W] 50%	DC [W] 60%	DC [W] 70%	DC [W] 100%	Control gear/luminaire
1.9		2.4	3.2	EMpowerX LED NSI / ARTSIGN C EW
2.1		2.4	3.2	EMpowerX LED NSI / ARTSIGN C ED
4.1		4.3	4.5	EMpowerX LED NSI / COMSIGN 150
4.0		4.2	4.5	EMpowerX LED NSI / CROSSIGN 110
4.0		4.2	4.5	EMpowerX LED NSI / CROSSIGN 110 ERI
5.0		5.2	5.5	EMpowerX LED NSI / CROSSIGN 160
5.0		5.2	5.5	EMpowerX LED NSI / CROSSIGN 160 ERI
9.7		10.1	10.5	EMpowerX LED NSI / CUBESIGN 210
1.9		2.1	2.4	EMpowerX LED NSI / ERGOSIGN LED
3.6		4.5	5.5	EMpowerX LED NSI / ECOSIGN LED IP 65
9.0		9.5	10.5	EMpowerX LED NSI / FREESIGN 300
4.1		4.3	4.5	EMpowerX LED NSI / PURESIGN 150
4.1		4.3	4.5	EMpowerX LED NSI / PURESIGN 150 ERI
3.0		3.8	4.9	EMpowerX LED NSI / RESCLITE C
4.6		5.8	7.7	EMpowerX LED NSI / SQUARESIGN 300
13.0	14.1	15.3	17.4	PCA 1 x 14/24 T5 EXCEL one4all Ip xitec II
23.7	25.6	28.1	32.6	PCA 2 x 14/24 T5 EXCEL one4all Ip xitec II
17.7	19.3	20.8	24.3	PCA 1 x 21/39 T5 EXCEL one4all Ip xitec II
32.3	35.4	39.1	46.7	PCA 2 x 21/39 T5 EXCEL one4all Ip xitec II
23.0	25.0	27.2	32.0	PCA 1 x 28/54 T5 EXCEL one4all Ip xitec II
42.6	46.9	51.4	61.4	PCA 2 x 28/54 T5 EXCEL one4all Ip xitec II
27.6	30.4	33.3	40.4	PCA 1 x 35/49/80 T5 EXCEL one4all Ip xitec II
51.1	56.7	62.6	77.1	PCA 2 x 35/49 T5 EXCEL one4all Ip xitec II
19.8	21.1	22.8	27.1	PCA 1 x 14/24 T5 EXCEL one4all Ip xitec II
37.6	41.1	44.7	51.5	PCA 2 x 14/24 T5 EXCEL one4all Ip xitec II
33.3	33.0	35.8	43.8	PCA 1 x 21/39 T5 EXCEL one4all Ip xitec II
58.1	64.5	71.6	86.3	PCA 2 x 21/39 T5 EXCEL one4all Ip xitec II
38.0	42.1	46.3	55.1	PCA 1 x 35/49/80 T5 EXCEL one4all Ip xitec II
73.0	80.9	89.6	110.2	PCA 2 x 35/49 T5 EXCEL one4all Ip xitec II
41.2	44.2	48.4	57.0	PCA 1 x 28/54 T5 EXCEL one4all Ip xitec II
82.2	90.5	99.8	117.1	PCA 2 x 28/54 T5 EXCEL one4all Ip xitec II
61.3	67.8	74.4	90.6	PCA 1 x 35/49/80 T5 EXCEL one4all Ip xitec II
122.1	134.5	147.9	178.0	PCA 2 x 80 T5 EXCEL one4all Ip xitec II
15.0	15.9	17.3	19.4	PCA 1 x 18 T8 EXCEL one4all Ip xitec II
27.2	29.3	32.2	37.0	PCA 2 x 18 T8 EXCEL one4all Ip xitec II
25.1	27.4	32.8	35.3	PCA 1 x 36 T8 EXCEL one4all Ip xitec II
48.1	53.2	58.6	69.6	PCA 2 x 36 T8 EXCEL one4all Ip xitec II
36.9	41.1	44.6	54.1	PCA 1 x 58 T8 EXCEL one4all Ip xitec II
72.4	79.4	88.0	108.5	PCA 2 x 58 T8 EXCEL one4all Ip xitec II

## ONLITE central CPS – central battery system

## Ballast/lumen factor table

Emergency lighting level	Light source	Wattage	AC power [100%] 230 V/50 Hz								
			[VA]	DC [W] 5%	DC [W] 10%	DC [W] 15%	DC [W] 20%	DC [W] 30%	DC [W] 40%		
	TC-L/F	1/18 W	17.5	7.9	8.2	9.7	10.7	11.6	12.9		
		2/18 W	32.9	13.1	15.1	16.0	18.0	20.9	24.0		
		1/24 W	24.4	8.4	10.1	11.5	12.2	14.4	16.5		
		2/24 W	46.8	13.0	16.5	19.6	21.9	26.4	30.3		
		1/36 W	35.9	10.3	12.4	14.9	16.4	19.7	23.2		
		2/36 W	70.5	16.1	21.2	25.8	30.0	36.6	43.6		
		1/40 W	45.5	8.8	12.0	14.9	17.4	22.2	26.6		
		2/40 W	88.2	17.3	23.4	29.4	34.6	43.8	53.1		
	TC-S/E	1/11 W	15.2	6.4	7.5	8.2	8.6	9.8	11.2		
		2/11 W	27.1	8.7	10.4	11.7	13.1	15.3	17.3		
			TC-D/E	1/13 W	15.0	6.4	7.5	7.8	8.5	10.2	11.2
				2/13 W	27.7	9.1	11.0	12.6	14.0	16.3	18.1
			TC-D/T	1/18 W	20.2	7.0	8.5	10.0	11.1	12.8	14.2
				2/18 W	38.4	11.1	13.6	16.4	18.1	22.2	25.3
				1/26 W	27.9	8.7	10.5	12.4	13.6	15.9	18.5
				2/26 W	52.6	14.1	17.4	21.0	23.7	28.5	33.0
	TC-T/E	1/32 W	33.1	9.4	12.1	14.1	16.0	19.0	22.3		
		2/32 W	57.9	14.5	19.7	24.5	28.1	34.4	40.0		
		1/42 W	40.2	10.4	13.0	15.6	18.5	22.9	27.7		
		2/42 W	74.9	15.4	21.8	27.4	31.8	40.5	48.5		
	TC-DD	1/28 W	30.5	8.9	10.6	12.6	13.9	16.6	18.9		

DC [W] 50%	DC [W] 60%	DC [W] 70%	DC [W] 100%	Control gear/luminaire
14.2	14.9	15.7	17.7	PCA 1 x 18/24 TCL EXCEL one4all c xitec II
25.9	28.0	30.6	33.1	PCA 2 x 18/24 TCL EXCEL one4all c xitec II
18.2	19.3	20.8	24.6	PCA 1 x 18/24 TCL EXCEL one4all c xitec II
34.0	37.0	40.6	47.1	PCA 2 x 18/24 TCL EXCEL one4all c xitec II
25.5	27.7	30.0	36.3	PCA 1 x 21/39 T5 EXCEL one4all lp xitec II
48.6	53.8	59.5	70.9	PCA 2 x 21/39 T5 EXCEL one4all lp xitec II
30.5	33.6	37.0	46.1	PCA 1 x 21/39 T5 EXCEL one4all lp xitec II
60.4	67.1	74.5	89.0	PCA 2 x 21/39 T5 EXCEL one4all lp xitec II
44.9	49.0	53.7	64.4	PCA 1 x 35/49/80 T5 EXCEL one4all lp xitec II
86.1	94.8	105.2	125.4	PCA 2 x 80 T5 EXCEL one4all lp xitec II
12.4	13.0	14.4	15.3	PCA 1 x 11/13 TC EXCEL one4all xitec II
19.6	21.1	23.0	27.0	PCA 2 x 11/13 TC EXCEL one4all xitec II
11.9	13.1	13.9	15.0	PCA 1 x 11/13 TC EXCEL one4all xitec II
21.0	21.0	24.1	27.8	PCA 2 x 11/13 TC EXCEL one4all xitec II
15.6	16.8	18.0	20.2	PCA 1 x 18 TC EXCEL one4all xitec II
28.2	30.7	33.5	37.5	PCA 2 x 18 TC EXCEL one4all xitec II
20.4	22.2	24.0	27.7	PCA 1 x 26-57 TC EXCEL one4all xitec II
37.4	40.7	45.0	52.7	PCA 2 x 26/32/42 TC EXCEL one4all xitec II
25.0	26.4	29.0	32.4	PCA 1 x 26-57 TC EXCEL one4all xitec II
44.6	47.9	51.7	58.3	PCA 2 x 26/32/42 TC EXCEL one4all xitec II
31.4	35.0	37.1	44.9	PCA 1 x 26-57 TC EXCEL one4all xitec II
55.6	60.1	65.2	74.5	PCA 2 x 26/32/42 TC EXCEL one4all xitec II
21.6	23.6	25.8	30.5	PCA 1 x 28 TC-DD EXCEL one4all xitec II



## Technology and tables

---

<b>Protection classes</b>	171
<b>Degrees of protection</b>	172
<b>Fire protection</b>	174
<b>Explosion-proofness</b>	176
<b>Ball-proofness</b>	178
<b>IK impact resistance level</b>	179
<b>Cleanroom technology</b>	180
<b>Fusing and rating of circuits</b>	182
<b>Impact on materials</b>	190
<b>Maintenance of lighting systems</b>	
Environmental conditions	195
Lamp luminous flux maintenance factor (LLMF) and lamp survival factor (LSF)	196
Table for luminaire maintenance factor (LMF)	202
Table for room maintenance factor (RMF)	202
Table of burning hours	204

---



## Protection classes

Protection classes describe measures providing protection against touch-sensitive voltages. These measures are set out in the EN 61140 standard and marked with symbols in compliance with IEC 60417.

Zumtobel luminaires are classified into the following classes of protection:

 = **Protection class I**

 = **Protection class II**

 = **Protection class III**

### Class I luminaires

The luminaire is designed for connection to a protective conductor.

Protection class I is not identified by a symbol. The symbol indicating the protective earth  is often used.

Unless specified otherwise, all luminaires by Zumtobel comply at least with protection class I.

### Class II luminaires

Class II luminaires have total insulation but no protective earth terminal.

The Zumtobel range includes protection class II luminaires, for instance moisture-proof batten luminaires and moisture-proof diffuser luminaires.

### Class III luminaires

Class III identifies luminaires that are intended for operation with protective extra low voltage (50 V max.).

Architectural luminaires such as 2LIGHT MINI and MICROS-S are protection class III luminaires.

## Degrees of protection

Degrees of protection indicate the following properties of equipment:

- the quality of its protection against direct contact
- its sealing against ingress of solid foreign bodies (dust, stones, sand, etc.)
- its sealing against the ingress of water

The type of protection is defined by two degrees of protection in accordance with IEC 529:

- degree of shock-hazard protection and protection against ingress of solid foreign bodies (1<sup>st</sup> digit)
- degree of protection against the ingress of water (2<sup>nd</sup> digit)

**For example**

**IP23:**

**IP**

**INGRESS PROTECTION**

**2**

**3**

Protection against ingress of solid foreign bodies having  $\varnothing > 12$  mm (medium-sized solid bodies), insertion of fingers or objects.

Protection against ingress of water falling at any angle up to 60° from vertical. There must be no adverse effect (spray water).

## Degrees of protection for technical luminaires

### Protection against ingress of solid foreign bodies as per first digit

- IP0X** Unprotected against ingress of solid foreign bodies
- IP1X** Protection against solid bodies  $> 50$  mm
- IP2X** Protection against solid bodies  $> 12$  mm
- IP3X** Protection against solid bodies  $> 2.5$  mm
- IP4X** Protection against solid bodies  $> 1$  mm
- IP5X** Dust-protected (limited ingress of dust)
- IP6X** Dust-tight (no ingress of dust)

### Protection against moisture as per second digit

- IPX0** No special protection
- IPX1** Drip-proof – protection against water drops
- IPX2** Protection against water drops up to 15° from the vertical
- IPX3** Rainproof – protection against spray water up to 60°
- IPX4** Splash-proof – protection against spray water from all directions
- IPX5** Jet-proof – protection against jets of water
- IPX6** Protection against heavy seas (conditions on ship decks)
- IPX7** Watertight – protection against immersion (pressure and time specified)
- IPX8** Protection against immersion under pressure (with instructions from manufacturer)



## Applications for luminaires with increased protection

### Damp locations

Bakeries	<b>IPX1</b>	The following generally applies:
Manure sheds	<b>IPX1</b>	IPX5: for cleaning using water jets
Animal-feed preparation facilities	<b>IPX1</b>	IPX4: in rinsing areas
Industrial kitchens	<b>IPX1</b>	
Boiler rooms	<b>IPX1</b>	
Commercial workshops	<b>IP20</b>	
Granaries	<b>IPX1</b>	
(Deep-freeze) cold storage	<b>IPX1</b>	
Pump houses	<b>IPX1</b>	
Sculleries	<b>IPX1</b>	
Laundries	<b>IPX1</b>	

### Wet locations

Beer or wine cellars	<b>IPX4</b>	The following generally applies:
Shower cubicles	<b>IPX4</b>	IPX5: for cleaning using water jets
Meat processing facilities	<b>IPX5</b>	
Electroplating facilities	<b>IPX4</b>	
Greenhouses	<b>IPX4</b>	
Dairies	<b>IPX4</b>	
Workshops using wet processes	<b>IPX4</b>	
Car wash areas	<b>IPX4</b>	

### Agricultural facilities

Beer or wine cellars	<b>IP44</b>	The following generally applies:
Shower cubicles	<b>IP44</b>	IPX5: for cleaning using water jets
Stores, storerooms for hay, straw, feedstuff	<b>IP44</b>	IP54+FF: when increased fire risk
Intensive stock farming	<b>IP44</b>	
Animal sheds	<b>IP44</b>	
Adjoining rooms of animal sheds	<b>IP44</b>	

### Facilities with increased fire risk

Workrooms	<b>IP50</b>
Woodworking	<b>IP50</b>
Sawmills	<b>IP50</b>
Paper processing	<b>IP50</b>
Textile processing	<b>IP50</b>
Treatment and fabrication	<b>IP50</b>

### Gymnasia and sports halls

Badminton courts	<b>IP20</b>	ballproof luminaires
Squash courts	<b>IP20</b>	ballproof luminaires with
Indoor tennis courts	<b>IP20</b>	all-round cover;
Gymnasia and sports halls	<b>IP20</b>	maximum mesh size 60 mm



## Fire protection



### Luminaire identification marking

The following criteria must be taken into account:

- position of normal use
- fire behaviour of environment and mounting surfaces
- minimum clearance from combustible substances and materials

#### **Luminaires marked with**

This symbol indicates the surface temperature of luminaire. External surfaces where highly flammable materials such as dust or fibres may accumulate, even in case of use according to purpose, must not exceed specific temperatures.

The  luminaire mark was withdrawn in 1999. A period of transition was agreed that allowed the  mark to be applied until 01/08/2005. Since 01/08/1998, the  mark introduced by EN 60598 has been applied.

The  mark limits the temperature to 90 °C max. on horizontal surfaces during normal operation and to 115 °C in the event of a ballast fault. On vertical surfaces, 150 °C must not be exceeded.

#### **Luminaires with the mark**

Luminaires which carry the  mark are intended for installation in furniture. They are designed so that in the event of a ballast fault, flame-retardant and normally flammable materials as specified in DIN 4102 cannot be ignited, e.g. in corners of wooden furniture. The materials may be painted, veneered or varnished.

#### **Luminaires with the mark**

Luminaires which carry the  mark are intended for mounting in or on furniture made of materials whose flammability is not known. They are designed so that in normal operation any mounting surface or other adjacent furniture surfaces do not exceed a temperature of 95 °C.

## Fire protection: Place of use – Mark – Requirements

Place of use	Luminaire mark	Requirements for luminaires with discharge lamps		
Building parts made of non-combustible building materials according to DIN 4102 Part 1		as specified in EN 60598-1		
Building parts made of flame-retardant building materials according to DIN 4102 Part 1	▽	as specified in EN 60598-1 on the mounting surface		
		<b>Mounting surface</b>	<b>Operation</b>	
		< 130 °C	abnormal	
		< 180 °C	ballast fault	
Facilities with increased fire risk according to DIN VDE 0100 Part 720	▽ <b>IP5X</b>	as specified in EN 60598-2-24 luminaire surfaces		
		<b>horizontal</b>	<b>vertical</b>	<b>Operation</b>
		< 90 °C	< 150 °C	normal
		< 115 °C	< 150 °C	abnormal/ ballast fault
Agricultural facilities with increased fire risk according to DIN VDE 0100 Part 720 DIN VDE 0100 Part 705 VDS 8/83 Form 2033	▽ <b>IP54</b> Installation marking	as specified in EN 60598-2-24 luminaire surfaces		
		<b>horizontal</b>	<b>vertical</b>	<b>Operation</b>
		< 90 °C	< 150 °C	normal
		< 115 °C	< 150 °C	abnormal/ ballast fault
Installation objects whose fire behaviour is specified as flame retardant or normally flammable in DIN 4102 Part 1	▽ Permissive location markings	as per DIN VDE 0710 Part 14 on the mounting surface and adjacent surfaces		
		<b>Mounting surface</b>	<b>Operation</b>	
		< 130 °C	abnormal	
		< 180 °C	ballast fault	
Installation objects with unknown fire behaviour	▽▽ Permissive location markings	as per DIN VDE 0710 Part 14 on the mounting surface and adjacent surfaces		
		<b>Mounting surface</b>	<b>Operation</b>	
		< 95 °C	normal	
		< 130 °C	abnormal	
		< 180 °C	ballast fault	

## Explosion-proofness

### Flammable gases, vapours and mists

#### Zone 0

A hazardous explosive atmosphere is present continuously or long term.

#### Zone 1

A hazardous explosive atmosphere can be expected to occur occasionally.

#### Zone 2

A hazardous explosive atmosphere can be expected to occur only rarely and, if any, short term.

### Combustible dusts

#### Zone 20

Includes areas in which there is a permanent, long-term or frequent explosive atmosphere consisting of dust-air mixtures.

#### Zone 21

Includes areas in which an explosive atmosphere consisting of dust-air mixtures can be expected to occur occasionally and short term.

#### Zone 22

Includes areas in which an explosive atmosphere cannot be expected to occur due to disturbance of deposited dust. If an explosive atmosphere should nevertheless occur, this will most probably happen only rarely and short term.

### Directive 94/9/EC

Directive 94/9/EC specifies the requirements for all devices and protection systems for use in explosion-prone areas. Over and above this, this Directive now directly includes the “Basic safety requirements” for explosion-proof equipment.

Manufacturers of explosion-proof equipment have to provide evidence of a quality assurance system to be tested by a “notified body”.

### Directive 99/92 EC (Workplace Directive)

Also important is the description of hazard areas in explosion-prone workplaces, and a resulting graded safety profile for the “equipment” used.

As this Directive was drafted according to the EC’s “new approach”, the manufacturer’s declaration of conformity, combined with CE marking of the products, was introduced for explosion-proof equipment as well.

A detailed commentary on Directive 94/9/EC is included in the “Directive 94/9/EC by the European Parliament and the Council of 23 March 1994” section. Since 1 July 2003, it has superseded all directives on explosion protection previously effective at European level.

## Equipment of Group 2 including potential ignition source

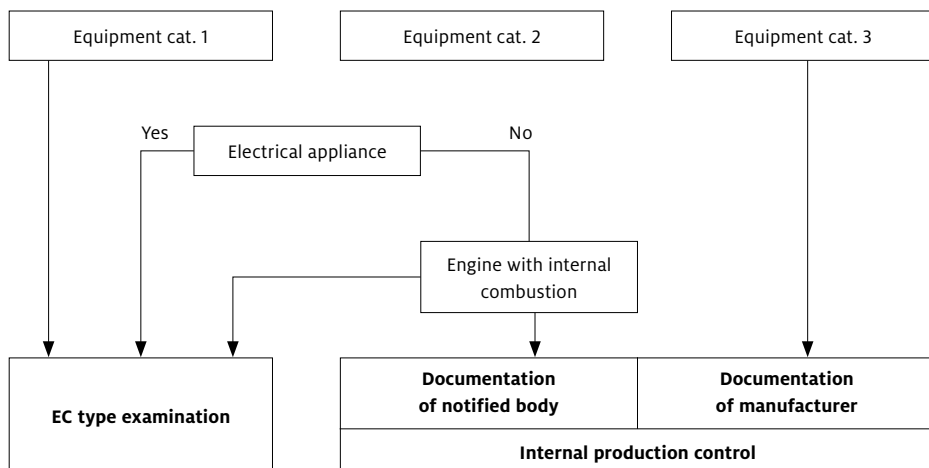

Basic safety and health requirements

## Classification of max. surface temperatures in electrical equipment of Class 2

Temperature class	Max. permissible surface temperature of equipment in °C	Ignition temperatures of flammable substances in °C
T1	450	> 450
T2	300	> 300 ≥ 450
T3	200	> 300 ≥ 200
T4	135	> 200 ≥ 135
T5	100	> 100 ≥ 135
T6	85	> 85 ≥ 100

## Ball-proofness

Luminaires for sports halls must be ball-proof according to DIN VDE 0710-13.

Balls hitting luminaires must not damage them so as to cause luminaire parts to fall down. In a test conforming with the relevant standard, the luminaire has to withstand 36 hits from three directions at a maximum impact speed of 60 km/h, the ball used having the size of a handball.

When choosing the luminaires, the rod guard's grid width must be matched to the sport played in the hall: it must always be considerably smaller than the balls used, never of the same size, as balls may get stuck in the guard.

## IK impact resistance level

The *IK impact resistance level* or *IK degree of protection* is a measure of the resistance of enclosures for electrical control gear against mechanical stress. The international standard IEC 62262 (corresponds to EN 62262) lists 10 degrees of protection:

Degree of protection	Impact energy (Joule)
IK00	No impact resistance
IK01	Up to 0.15
IK02	Up to 0.20
IK03	Up to 0.35
IK04	Up to 0.50
IK05	Up to 0.70
IK06	Up to 1.0
IK07	Up to 2.0
IK08	Up to 5.0
IK09	Up to 10.0
IK10	Up to 20.0

This provides information about the impact energy, which an enclosure can withstand without breaking. One can expect the following maximum loads in practice:

- up to IK05: blows with the hand or fist
- IK06: blows with a 500 g hammer from a distance of 20 cm
- IK07: blows with a 500 g hammer from a distance of 40 cm
- IK08: blows with a 1.7 kg hammer from a distance of 30 cm
- IK09: blows with a 5 kg hammer from a distance of 20 cm
- IK10: blow with a baseball bat, projectiles, kicks

## Cleanroom technology

### Cleanroom compatibility tested

CLEAN Advanced and CLEAN Supreme have been tested and assessed by the Fraunhofer Institute in Stuttgart (Germany) with respect to

- cleanroom compatibility for cleanrooms (particle emission behaviour of the luminaires) and
- cleanliness compatibility (disinfectability, electrostatic behaviour and chemical resistance).

### Details on cleanroom compatibility

The German VDI 2083 Guideline specifies a standardised procedure for all equipment used in a cleanroom.

The common criterion for the cleanroom compatibility of luminaires and all other equipment is their particle emission behaviour. "Airborne particle emission" is used as a classification criterion in all international standards. The relevant maximum value for the permissible concentration of particles of a specific particle size constitutes the class limit.

### Test setup

A defined volume of air is aspirated by an air sampling probe and fed into a test chamber. The particles inside this test chamber are monitored and recorded appropriately.

Exceeding the relevant limit values is decisive in order to classify the luminaires. If a limit value is not exceeded with a certainty of at least 95%, the respective item of equipment may be regarded as suitable for use in this air cleanliness class.

### Details on cleanliness compatibility

In order to be able to confirm *cleanliness compatibility*, as well as, quantities reflecting cleanroom compatibility that can be detected by metrological methods, additional expert assessments and parameters were included in the tests conducted by the Fraunhofer Institute IPA.

Cleanliness compatibility covers a large number of *sector-based cleanliness requirements* such as resistance to chemicals, surface quality, flow behaviour or electrostatic charge characteristics. These are defined in the following *standards and codes of practice*, among others:



## Standardisation

### General:

- classification of air cleanliness – clean-rooms and associated controlled environments according to DIN EN ISO 14644-1 (Federal Standard 209 has been withdrawn)
- cleanroom technology and cleanroom compatibility of equipment VDI 2083
- EHEDG (European Hygienic Engineering & Design Group)

### Industrial application areas:

- GMP Guidelines (Good Manufacturing Practice) – pharmaceuticals
- FDA (Food and Drug Administration) – pharmaceuticals and foodstuffs
- Medicinal Product Law
- EU Pharmaceutical Regulation – Good manufacturing practices Volume 4 – (Medicinal products for human and veterinary use)
- Hazard Analytical Control Point (HACCP) Regulations – foodstuffs

### Hospital application areas:

- VDI 2167 Building services in hospitals
- DIN 1946-4 Ventilation and air conditioning Part 4 (Ventilation in hospitals)

### Airflow systems in cleanrooms

One of the basic criteria for the requirements placed on equipment in cleanrooms is the nature of the airflow system. The CLEAN luminaire has been designed for use in all cleanroom classes with a *turbulent mixed airflow*. In this commonly encountered airflow system, air enters the room with a turbulent flow, thereby causing continuous dilution and “cleaning”. According to GMP (Good Manufacturing Practice) classification, cleanroom Classes C to E and ISO Classes 6 to 9 can be achieved using this airflow system.

Cleanrooms with *low-turbulence displacement flow*, which are more expensive to build, allow air to initially enter the cleanroom with low turbulence. The design of laminar flow cleanrooms precludes the use of any luminaires other than extremely slim batten luminaires which disrupt the directional flow of air as little as possible. The laminar flow system minimises contamination, and any contaminant is quickly eliminated. Cleanrooms in ISO Classes 1 to 6 and GMP Classes A and B are areas where this airflow system is used.

## Fusing and rating of circuits

### Tripping values of line circuit-breakers

Tripping characteristics	Tripping current
B (quick-acting)	3 to 5-fold rated current
C	5 to 10-fold rated current

For the operation of luminaires, automatic circuit breakers with C characteristics are recommended. In case of multipolar circuit breakers, the values specified by the manufacturer must be reduced by 20%. The levels indicated in the table refer to simultaneous switch-on at the mains voltage peak with UN = 230 V.

Please note: the values given in the table are intended as reference values only and may deviate in individual cases. The specific range and type, as well as, the actual number of ballasts per luminaire must be taken into account. In case of metal halide lamps, the switch-on current is increased by ignition time shunting. In case of connection to circuit breakers with B characteristics, transformers should not be loaded above rating in order to avoid false tripping.

## Loading of automatic circuit breakers for metal halide lamps – maximum recommended number of electronic ballasts per automatic circuit breaker

Electronic ballasts for HIT/HIT-DE/HIE and

HIT-CE/HIT-TC-C²E/HIT-DE-CE/HIE-CE metal halide lamps, non-dimmable (TRIDONIC PCI range):

	C10	C13	C16	C20	B10	B13	B16	B20
mm²	1.5	1.5	1.5	2.5	1.5	1.5	1.5	2.5
1/20 W HI	24	33	42	48	12	15	19	19
1/35 W HI	16	22	28	32	8	10	13	13
1/70 W HI	10	18	26	30	6	10	13	13
1/150 W HI	7	14	20	20	4	6	7	7

## Loading of automatic circuit breakers for electronic ballasts for fluorescent and compact fluorescent lamps – maximum recommended number of electronic ballasts per automatic circuit breaker

Electronic ballasts for T16 fluorescent lamps, not dimmable

(TRIDONIC PC T5 PRO range):

	C10	C13	C16	C20	B10	B13	B16	B20
mm²	1.5	1.5	1.5	2.5	1.5	1.5	1.5	2.5
1/14 W T16	46	80	80	140	23	40	40	70
2/14 W T16	46	80	80	140	23	40	40	70
3/14 W T16	30	46	50	64	15	23	25	32
4/14 W T16	30	46	50	64	15	23	25	32
1/21 W T16	46	80	86	98	23	40	43	49
2/21 W T16	46	78	80	100	23	39	40	50
1/28 W T16	44	78	80	90	22	39	40	45
2/28 W T16	18	28	30	36	9	14	15	18
1/35 W T16	46	80	80	140	23	40	40	70
2/35 W T16	20	30	30	44	10	15	15	22
1/24 W T16	46	80	80	140	23	40	40	70
2/24 W T16	30	50	50	64	15	25	25	32
1/39 W T16	30	40	50	60	15	20	25	30
2/39 W T16	18	28	30	36	9	14	15	18
1/54 W T16	30	46	50	80	15	23	25	40
2/54 W T16	14	20	24	30	7	10	12	15
1/49 W T16	30	46	50	58	15	23	25	29
2/49 W T16	18	28	30	36	9	14	15	18
1/80 W T16	18	28	30	36	9	14	15	18

## Fusing and rating of circuits

### Loading of automatic circuit breakers for electronic ballasts for fluorescent and compact fluorescent lamps – maximum recommended number of electronic ballasts per automatic circuit breaker

Electronic ballasts for T16 fluorescent lamps, Basic dimmable/DALI-dimmable (TRIDONIC PCA T5 ECO/PCA T5 EXCEL one4all ranges):

	<b>C10</b>	<b>C13</b>	<b>C16</b>	<b>C20</b>	<b>B10</b>	<b>B13</b>	<b>B16</b>	<b>B20</b>
mm <sup>2</sup>	1.5	1.5	1.5	2.5	1.5	1.5	1.5	2.5
1/14 W T16	30	50	70	80	15	25	35	40
2/14 W T16	22	32	44	50	11	16	22	25
3/14 W T16	16	26	34	42	8	13	17	21
4/14 W T16	16	24	34	38	8	12	17	19
1/21 W T16	30	50	70	76	15	25	35	38
2/21 W T16	22	32	44	50	11	16	22	25
1/28 W T16	32	50	72	80	16	25	36	40
2/28 W T16	16	22	30	34	8	11	15	17
1/35 W T16	32	50	70	80	16	25	35	40
2/35 W T16	16	22	30	34	8	11	15	17
1/24 W T16	22	32	44	50	11	16	22	25
2/24 W T16	22	32	46	52	11	16	23	26
1/39 W T16	22	32	44	50	11	16	22	25
2/39 W T16	14	22	28	34	7	11	14	17
1/54 W T16	22	32	44	50	11	16	22	25
2/54 W T16	14	22	28	34	7	11	14	17
1/80 W T16	10	20	30	30	5	10	15	15

Electronic ballasts for T26 fluorescent lamps, non-dimmable (TRIDONIC PC E011/PC T8 PRO ranges):

	<b>C10</b>	<b>C13</b>	<b>C16</b>	<b>C20</b>	<b>B10</b>	<b>B13</b>	<b>B16</b>	<b>B20</b>
mm <sup>2</sup>	1.5	1.5	1.5	2.5	1.5	1.5	1.5	2.5
1/18 W T26	46/46	80/80	104/140	110/140	23/23	40/40	52/70	55/70
2/18 W T26	30/44	46/80	68/140	84/140	15/22	23/40	34/70	42/70
3/18 W T26	32/-	46/-	66/-	80/-	16/-	23/-	33/-	40/-
4/18 W T26	20/-	30/-	40/-	44/-	10/-	15/-	20/-	22/-
1/36 W T26	32/46	48/80	70/140	84/140	16/23	24/40	35/70	42/70
2/36 W T26	20/20	30/30	40/42	44/44	10/10	15/15	20/21	22/22
1/58 W T26	32/32	46/46	66/66	80/80	16/16	23/23	33/33	40/40
2/58 W T26	14/14	20/20	26/26	30/30	7/7	10/10	13/13	15/15

Electronic ballasts for T26 fluorescent lamps, Basic dimmable/DALI-dimmable  
(TRIDONIC PCA T8 ECO/PCA T8 EXCEL one4all ranges):

	<b>C10</b>	<b>C13</b>	<b>C16</b>	<b>C20</b>	<b>B10</b>	<b>B13</b>	<b>B16</b>	<b>B20</b>
mm <sup>2</sup>	1.5	1.5	1.5	2.5	1.5	1.5	1.5	2.5
1/18 W T26	30	50	80	80	15	25	40	40
2/18 W T26	20	30	40	46	10	15	20	23
3/18 W T26	12	18	24	30	6	9	12	15
4/18 W T26	12	16	24	28	6	8	12	14
1/30 W T26	30	50	70	76	15	25	35	38
2/30 W T26	10	20	30	30	5	10	15	15
1/36 W T26	30	50	70	76	15	25	35	38
2/36 W T26	10	20	30	30	5	10	15	15
1/58 W T26	20	30	40	46	10	15	20	23
2/58 W T26	10	20	30	30	5	10	15	15

Electronic ballasts for TC-L compact fluorescent lamps, Basic dimmable/DALI-dimmable  
(TRIDONIC PCA TCL ECO/PCA TCL EXCEL one4all ranges):

	<b>C10</b>	<b>C13</b>	<b>C16</b>	<b>C20</b>	<b>B10</b>	<b>B13</b>	<b>B16</b>	<b>B20</b>
mm <sup>2</sup>	1.5	1.5	1.5	2.5	1.5	1.5	1.5	2.5
1/18 W TC-L	52	56	64	96	26	28	32	48
2/18 W TC-L	52	56	64	96	26	28	32	48
1/24 W TC-L	52	56	64	96	26	28	32	48
2/24 W TC-L	20	26	32	40	10	13	16	20
1/36 W TC-L	30	50	70	76	15	25	35	38
2/36 W TC-L	10	20	30	30	5	10	15	15
1/40 W TC-L	30	50	70	76	15	25	35	38
2/40 W TC-L	10	20	30	30	5	10	15	15
1/55 W TC-L	20	30	40	46	10	15	20	23
2/55 W TC-L	10	14	18	20	5	7	9	10
1/80 W TC-L	10	20	30	30	5	10	15	15

## Fusing and rating of circuits

### Loading of automatic circuit breakers for electronic ballasts for fluorescent and compact fluorescent lamps – maximum recommended number of electronic ballasts per automatic circuit breaker

Electronic ballasts for TC-L compact fluorescent lamps, non-dimmable  
(TRIDONIC PC PRO FSD ranges):

		<b>C10</b>	<b>C13</b>	<b>C16</b>	<b>C20</b>	<b>B10</b>	<b>B13</b>	<b>B16</b>	<b>B20</b>
	mm <sup>2</sup>	1.5	1.5	1.5	2.5	1.5	1.5	1.5	2.5
1/18 W TC-L		30	50	80	80	15	25	40	40
2/18 W TC-L		30	50	80	80	15	25	40	40
1/24 W TC-L		30	50	80	80	15	25	40	40
2/24 W TC-L		30	50	80	80	15	25	40	40
1/36 W TC-L		80	80	80	100	40	40	40	50
2/36 W TC-L		20	30	40	40	10	15	20	20
1/40 W TC-L		30	50	80	80	15	25	40	40
2/40 W TC-L		14	20	26	30	7	10	13	15
1/55 W TC-L		20	30	40	40	10	15	20	20
2/55 W TC-L		10	14	20	22	5	7	10	11
1/80 W TC-L		18	28	30	36	9	14	15	18

Electronic ballasts for TC-DEL/TEL fluorescent lamps, non-dimmable  
(TRIDONIC PC PRO range):

		<b>C10</b>	<b>C13</b>	<b>C16</b>	<b>C20</b>	<b>B10</b>	<b>B13</b>	<b>B16</b>	<b>B20</b>
	mm <sup>2</sup>	1.5	1.5	1.5	2.5	1.5	1.5	1.5	2.5
1/13 W TC-DEL/TC-TEL		80	80	80	100	40	40	40	50
2/13 W TC-DEL/TC-TEL		80	80	80	100	40	40	40	50
1/18 W TC-DEL/TC-TEL		80	80	80	100	40	40	40	50
2/18 W TC-DEL/TC-TEL		30	50	80	80	15	25	40	40
1/26 W TC-DEL/TC-TEL		30	50	80	80	15	25	40	40
2/26 W TC-DEL/TC-TEL		32	50	80	80	16	25	40	40
1/32 W TC-TEL		30	50	80	80	15	25	40	40
2/32 W TC-TEL		16	22	30	44	8	11	15	22
1/42 W TC-TEL		30	50	80	80	15	25	40	40
2/42 W TC-TEL		16	22	30	44	8	11	15	22
1/57 W TC-TEL		20	30	30	44	10	15	15	22

Electronic ballasts for TC-DEL/TEL compact fluorescent lamps Basic dimmable/DALI-dimmable  
(TRIDONIC PCA ECO/PCA EXCEL one4all ranges):

	<b>C10</b>	<b>C13</b>	<b>C16</b>	<b>C20</b>	<b>B10</b>	<b>B13</b>	<b>B16</b>	<b>B20</b>
mm <sup>2</sup>	1.5	1.5	1.5	2.5	1.5	1.5	1.5	2.5
1/13 W TC-DEL/TC-TEL	40	60	80	80	20	30	40	40
2/13 W TC-DEL/TC-TEL	28	40	60	64	14	20	30	32
1/18 W TC-DEL/TC-TEL	30	50	70	76	15	25	35	38
2/18 W TC-DEL/TC-TEL	22	32	46	68	11	16	23	34
1/26 W TC-DEL/TC-TEL	30	50	70	76	15	25	35	38
2/26 W TC-DEL/TC-TEL	22	32	46	56	11	16	23	28
1/32 W TC-TEL	26	38	50	58	13	19	25	29
2/32 W TC-TEL	10	18	24	28	5	9	12	14
1/42 W TC-TEL	26	38	50	58	13	19	25	29
2/42 W TC-TEL	10	18	24	28	5	9	12	14

## Fusing and rating of circuits

### Loading of automatic circuit breakers for low-voltage halogen incandescent lamps – maximum recommended number of transformers per automatic circuit breaker

Magnetic transformers for  
QT/QR/QR-CB(C) halogen incandescent lamps  
(TRIDONIC TMBx/OMTx ranges):

	<b>C10</b>	<b>C16</b>	<b>B10</b>	<b>B16</b>
35 W	41	65	20	32
50 W	21	35	10	17
70 W	15	24	7	12
80 W	14	22	7	11
105 W	8	13	4	6
150 W	4	6	2	3
210 W	2-3	4-5	1	2
300 W	1-2	2-3	n.r.	1

n.r. = not recommended

Magnetic transformers for  
QT/QR/QR-CB(C) halogen incandescent lamps  
(TRIDONIC OGT range):

	<b>C10</b>	<b>C16</b>	<b>B10</b>	<b>B16</b>
20 W	42	67	21	33
35 W	35	56	17	28
40 W	26	43	13	21
50 W	23	37	11	18
60 W	21	33	10	16
70 W	16	26	8	13
80 W	13	21	6	10
105 W	9	14	4	7

Magnetic transformers for  
QT/QR/QR-CB(C) halogen incandescent lamps  
(TRIDONIC TMAx/TMDx ranges):

	<b>C10</b>	<b>C16</b>	<b>B10</b>	<b>B16</b>
250 W	3-4	5-6	1-2	2-3
300 W	2	3-4	1	1-2
500 W	1	1-2	n.r.	n.r.

n.r. = not recommended



## Automatic circuit breaker ratings for LED downlights and spotlights – maximum number of DLs recommended per automatic circuit breaker

The type of automatic circuit breakers and the corresponding maximum number of luminaires are specified in Zumtobel's online catalogue. Moreover, the LED luminaire's switch-on current and pulse width are also indicated at the bottom of the table.

Information about automatic circuit breakers is available at the respective product page under:

[zumtobel.com/com-en/products](http://zumtobel.com/com-en/products)



---



PANOS INF R150L 10W LED930 LDO FAL WH
Article no. 60 816 459

CONFIGURE PRODUCT

OVERVIEW
DATA SHEET
PHOTOMETRY
QUICKCALC
DOWNLOADS

Print view

**OVERVIEW**

800°C LED

PRODUCT DATA	
Description	PANOS INF R150L 10W LED930 LDO FAL WH
Article no.	60 816 459
EAN number	4053167246527
Light Source	LED
Luminaire luminous flux*	1134 lm
Luminaire efficacy*	113 lm/W
Colour Rendering Index min.	90
Ballast	1 x 28001408 DRV TR LCA 10W 400mA 60V quantity with B10: 20 pcs. quantity with B13: 28 pcs. ✓ quantity with B16: 32 pcs. quantity with B20: 40 pcs. quantity with C10: 40 pcs. quantity with C13: 56 pcs. quantity with C16: 64 pcs. quantity with C20: 80 pcs.
Miniature circuit breaker	
Correlated colour temperature*	
Chromaticity tolerance (initial MacAdam)*	
Rated median useful life*	Inrush current 10.3 A Pulse duration 230 µs
Luminaire input power*	
Standby Power*	0.14 W
Dimming	LDO dimmable to 1% over DALI
Maintenance category	C - Closed Top Reflector

**Product description**

- Picture
- Product Description
- Brochure

**Design data**

- Photometric LDT
- Photometric IES
- Transfer to QUICKCALC, VIVALDI, DALI FC or HSLITE
- Transfer to DALIux
- Transfer to RaLux
- Family datasheet
- Datasheet
- Photometric Datasheet
- Combination Datasheet
- Circuit breaker data
- Label acc. EU Reg. 874/2012
- Test mark certificate
- CE - Declaration of Conformity
- ENEC certificate
- 2D CAD drawing
- 3D CAD drawing

**Handling**

- Dimensional sketch
- Installation instruction

[Select all](#)  
[Reset](#)  
[Generate ZIP](#)

## Impact on materials

No material is resistant to all chemical influences. This is not really surprising, as there are so many chemicals and so many effects; in fact, they fill whole volumes with resistance tables.

When assessing potential hazards, the degree of saturation of chemical substances and the ambient temperature must be taken into account.

The accompanying tables therefore only provide a brief overview of frequently encountered applications and chemical impact.

If you are unsure or have specific questions, your Zumtobel adviser will be happy to assist.

### Excellent properties

	PC	PMMA	CHEMO	Polyester
IK code	08	03	07	03
UV resistance	+ **	++	++	++
Shock resistance	6 Nm	0.2 Nm	4 Nm	0.35 Nm
Resistance to ageing	+ *	++	++	++
Silicone-free	Yes	Yes	Yes	Yes
Halogen-free	Yes	Yes	Yes	Yes
International Food Standards (IFS) certification	Yes	Yes	Yes	Yes
Glow-wire tested	850 °C	650 °C	850 °C	850 °C
Heat resistance of luminaire plastics	130 °C	90 °C*	122 °C	
Flammability acc. to UL94 (ISO 60695)	V2	HB	HB	HB
UV transmittance	89%	91%	89%	

\* limited UV stability of PC \*\* UV stabilised

### Recommendations according to application area

	PC	PMMA	CHEMO
<b>Damp locations</b>			
Bake houses	■	■	■
Damp cellars	-	■	■ ■
Fodder kitchens	■	■	■
Large-scale catering establishments	■	■	■

■ ■ highly recommended ■ suitable - unsuitable

→ to be continued on the next page

\* with plastic catches and special ceiling brackets (available on request)

## Recommendations according to application area

	PC	PMMA	CHEMO
<b>Wet locations</b>			
Beer and wine cellars	■	■	■
Breweries	–	■	■ ■
Wine cellars (using sulphur to steam out barrels)	–	■ ■	■ ■
Damp pump rooms	■	■	■
Meat-processing facilities	–	■	■ ■
Electroplating plants (caution: do not use V2A)	–	■ *	■ *
Conservatories	■	■	■
Cheese dairies	–	■ ■	■ ■
Dairies	–	■	■
Washing bays/car washes (motor vehicles)	–	■	■
Rooms or areas in bathhouses or laundries	■	■	■
Bathrooms/shower rooms	■	■	■
Thermal spas and brine baths	■	■	■
<b>Agricultural premises</b>			
Fodder preparation	■	■	■
Greenhouses	■	■	■
Storage areas/storerooms for hay, straw, fodder, fertilisers	■ ■	■	■
Areas for animal husbandry (stables)	–	■ ■	■
<b>Locations exposed to fire hazards (only version with electronic ballast is fire resistant)</b>			
Woodworking	■	■	■
Paper processing	–	■ ■	■
Textile processing plants	–	■ ■	■
Theatre workshops	■	■	■
Drying rooms	■	■	■
Garages	■	■	■
Underground garages	■	■	■
Car parks	■	■	■
Private garages	■	■	■
Vehicle depots	■	■	■
<b>Outdoor facilities</b>			
Facilities on ramps (canopied)	■	■	■
Gateways (canopied)	■	■	■
Canopied railway platforms	■	■	■
Canopied petrol stations	■	■	■
Canopy roofs	■	■	■

## Impact on materials

### Chemical resistance of materials

	PC	PMMA	CHEMO	Polyester
Acetic acid up to 5%	■	■	■	■
Acetic acid up to 30%	■	–	–	■
Acetone	–	–	■	–
Aliphatic hydrocarbons	■	■	■	■
Ammonia 25%	–	■	■	■
Aniline	–	–	–	–
Aromatic hydrocarbons	–	–	■	■
Battery acid	■	■	■	■
Beer	■	■	■	■
Benzene	–	–	■	–
Blood	■	■	■	■
Bromic acid	–	–	–	–
Carbon dioxide	■	■	■	■
Carbon monoxide	■	■	■	■
Carbon tetrachloride	–	–	■	■
Caustic potash solution 30%	–	■	■	–
Chloroform	–	–	■	–
Chlorophenol	–	–	–	–
Cleaner's naphtha (solvent)	■	■	■	■
Cresol	–	–	–	–
Dichloromethane	–	–	■	–
Diesel fuel	–	■	■	■
Diesel oil, crude oil	■	■	■	■
Dimethyl benzene	–	–	■	–
Dioxane	–	–	■	■
Ethanol < 30%	■	■	■	■
Ethanol > 30%	■	–	■	■
Ether	–	–	■	■
Ethyl acetate	–	–	■	–
Fats: animal	–	■	■	■
Fats: mineral	–	■	■	■
Fats: vegetable	–	■	■	■
Four-star petrol	–	–	■	■
Fuel oil	–	■	■	■
Glycerol	■	■	■	■

■ resistant – not resistant

The information given is valid under the following conditions: the chemical substance listed in the table is a basic material and not part of a chemical compound. The ambient temperature is 22°C.

	PC	PMMA	CHEMO	Polyester
Glycol	■	■	■	■
Glystantin®	■	■	■	■
Hydrochloric acid (HCl) < 20%	■	■	■	■
Hydrochloric acid (HCl) > 20%	■	■	–	■
Hydrogen peroxide over 40%	■	–	■	–
Hydrogen peroxide up to 40%	■	■	■	–
Hydrogen sulphide	■	■	■	■
Isopropyl alcohol	■	–	■	■
Ketones	–	–	■	–
Methyl alcohol	–	–	■	–
Milk of lime	■	■	■	■
Nitric acid over 20%	–	–	–	–
Nitric acid up to 10%	■	■	–	■
Nitric acid up to 20%	■	■	–	■
Petroleum ether	■	■	■	■
Phenol	–	–	–	–
Pyridine	–	–	■	–
Regular petrol	■	–	■	■
Seawater	■	■	■	■
Silicone oil	■	■	■	■
Soapsuds	■	■	■	■
Soda	■	■	■	■
Sodium hydroxide solution 2%	–	■	■	■
Sodium hydroxide solution 10%	–	■	■	–
Solution of sodium chloride	■	■	■	■
Spirit of turpentine	■	■	■	■
Sulphuric acid (H2SO4) < 50%	■	■	■	■
Sulphuric acid (H2SO4) < 70%	■	■	–	■
Sulphuric acid (H2SO4) > 70%	–	–	–	–
Sulphuric acid (H2SO4) > 98%	–	–	–	–
Sulphurous acid up to 5%	–	■	■	■
Synthetic detergent solution	■	■	■	■
Toluene	–	–	■	–
Trichloroethane	–	–	■	■
Water up to 60°C	■	■	■	■

■ resistant – not resistant

The information given is valid under the following conditions: the chemical substance listed in the table is a basic material and not part of a chemical compound. The ambient temperature is 22°C.

## Maintenance of lighting systems

Today, the maintenance of lighting installations is a decisive factor in an installation's balance of costs.

According to the formula below (1), a lighting level required of  $E_m = 500$  lx at a standard maintenance factor of  $MF = 0.67$  implies a new illuminance level of  $E_{new} = 750$  lx.

$E_m$ : maintained illuminance =  
maintenance value of illuminance

$$(1) E_m = E_{new} \times MF$$

### *Benefit of a high MF*

- lower luminaire investment costs
- reduced energy costs

### *Benefit of a low MF*

- low maintenance costs
- longer maintenance intervals

Please note: at a lower maintenance factor, illuminance may be constantly dimmed to the maintenance value to save energy (maintenance control).

## The maintenance factor includes 4 components

$$(2) MF = LLMF \times LSF \times LMF \times RMF$$

All these factors describe the decrease in illuminance. The maximum in each case is 1, corresponding to the new value. At the respective time of maintenance, the various causes of the decrease in illuminance must be identified.

### Maintenance factor components

- Lamp luminous flux mainten. factor LLMF
- Lamp survival factor LSF
- Luminaire maintenance factor LMF
- Room maintenance factor RMF

### Causes of illuminance decrease

- Ageing of lamps
- Failure of lamps
- Soiling of luminaire
- Soiling of room

### Options for improving the maintenance factor

- lamp replacement already before the lamp service life ends (LLMF/LSF ↗)
- immediate replacement of lamps in case of failure (LSF = 1)
- use of closed luminaires (LWF7 ↗)
- more frequent room cleaning (RWF7 ↗)

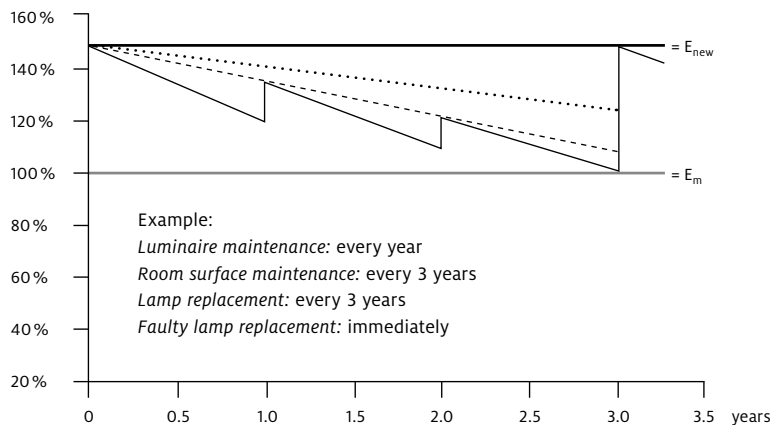

## Environmental conditions

In case you are not familiar with the application, the following standard values apply; however, the tables below will help you calculate the accurate maintenance factor according to formula (2).

Ambient condition	Maintenance interval recommended	Working areas	Reference maintenance factor
Very Clean (VC)	3 years	Cleanrooms, data centres, assembly workstations for electronic components	0.80
Clean (C)	3 years	Offices Schools	0.67
Normal (N)	2 years	Shops Laboratories Restaurants Warehouses Assembly bays	0.57
Soiled (S)	1 year	Steel works Chemical plants Foundries Welding shops Grinding shops Wood processing	0.50

According to CIE – volume 97, “Maintenance of indoor electric lighting systems”, as at 2005

## Maintenance of lighting systems

Lamp luminous flux maintenance factor (LLMF)  
and lamp survival factor (LSF)

Lamps		Service life given in hours					
		100	500	1000	1500	2000	4000
<b>Halogen incandescent lamp</b> CIE97:2005	LLMF	1.00	0.99	0.97		0.95	
	LSF	1.00	1.00	0.78		0.50	
<b>T26 (low-loss ballast) triple-band fluor. lamp</b> ZVEI 2005	LLMF	1.00	0.99	0.98	0.97	0.96	0.95
	LSF	1.00	1.00	0.99	0.99	0.98	0.98
<b>T26 (electronic ballast) triple-band fluor. lamp</b> ZVEI 2005/CIE97:2005	LLMF	1.00	0.99	0.98	0.97	0.96	0.95
	LSF	1.00	1.00	1.00	1.00	1.00	0.99
<b>T26 (electronic ballast) triple-band fluor. lamp, long-life</b> Philips MASTER TL-D Xtreme (long life)	LLMF	1.00	0.99	0.99	0.98	0.98	0.98
	LSF	1.00	1.00	1.00	1.00	1.00	1.00
<b>T26 (electronic ballast) triple-band fluor. lamp, long-life</b> AURA Ultimate LL (long life)	LLMF	1.00	1.00	1.00	1.00	0.98	0.98
	LSF	1.00	1.00	1.00	1.00	1.00	1.00
<b>T16 (electronic ballast) triple-band</b> ZVEI 2005	LLMF	1.00	0.99	0.98	0.97	0.96	0.95
	LSF	1.00	1.00	1.00	1.00	1.00	0.99
<b>T16 (electronic ballast) triple-band fluor. lamp, long-life</b> AURA SUPREME T5 HO LL (long life)	LLMF	1.00	1.00	0.99	0.99	0.98	0.96
	LSF	1.00	1.00	1.00	1.00	1.00	1.00
<b>Compact fluorescent lamp</b> CIE97:2005	LLMF	1.00	0.98	0.97		0.94	0.91
	LSF	1.00	0.99	0.99		0.98	0.97
<b>TC-S, TC-D, TC-T 5–26 W (low-loss ballast)</b> <b>Compact fluorescent lamp</b> ZVEI 2005	LLMF	1.00	0.98	0.97	0.95	0.93	0.86
	LSF	1.00	1.00	1.00	0.99	0.98	0.97
<b>TC-SEL, TC-TEL 5–42 W (electronic ballast)</b> <b>Compact fluorescent lamp</b> ZVEI 2005	LLMF	1.00	0.98	0.96	0.94	0.93	0.87
	LSF	1.00	1.00	0.99	0.99	0.99	0.98
<b>TC-DEL 10–26 W (electronic ballast)</b> <b>Compact fluorescent lamp</b> ZVEI 2005	LLMF	1.00	0.98	0.96	0.94	0.92	0.87
	LSF	1.00	1.00	1.00	0.99	0.99	0.98
<b>TC-L 18–36 W (low-loss ballast)</b> <b>Compact fluorescent lamp</b> ZVEI 2005	LLMF	1.00	0.99	0.98	0.97	0.96	0.92
	LSF	1.00	1.00	1.00	1.00	1.00	1.00
<b>TC-L 18–80 W (electronic ballast)</b> <b>Compact fluorescent lamp</b> ZVEI 2005	LLMF	1.00	0.99	0.98	0.97	0.97	0.94
	LSF	1.00	1.00	1.00	1.00	1.00	0.99

Values acc. to specifications by lamp manufacturers, January 2008, acc. to CIE97:2005

Technical report "Guide on the Maintenance of Indoor Electric Lighting Systems" 2nd edition, and ZVEI publication "Service life behaviour of discharge lamps for lighting" of November 2005.

For data of lamps by other manufacturers or other lamp types, please contact the respective manufacturer directly.

The use of state-of-the-art ballast technology is a prerequisite.

The switching frequency has a major influence on lamp survival.

Most data are based on the standardised 3-hour switching rhythm acc. to IEC (2.75 h ON, 0.25 h OFF).



6000	8000	10000	12000	14000	16000	18000	20000	22000	24000	30000	35000	40000	45000
0.94 0.97	0.93 0.95	0.92 0.93	0.92 0.83	0.91 0.60									
0.94 0.99	0.93 0.98	0.92 0.98	0.92 0.97	0.91 0.95	0.90 0.90	0.90 0.75	0.90 0.50						
0.97 1.00	0.96 1.00	0.95 1.00	0.95 1.00	0.94 1.00	0.94 1.00	0.93 1.00	0.93 1.00	0.93 1.00	0.92 1.00	0.91 1.00	0.90 0.98	0.90 0.90	0.90 0.70
0.97 1.00	0.97 1.00	0.97 1.00	0.96 1.00	0.95 1.00	0.95 1.00	0.94 1.00	0.94 0.99	0.94 0.99	0.93 0.99	0.92 0.99	0.91 0.99	0.91 0.99	0.91 0.99
0.94 0.99	0.93 0.98	0.92 0.98	0.92 0.98	0.91 0.97	0.90 0.97	0.90 0.96	0.90 0.91	0.90 0.80	0.89 0.50				
0.95 1.00	0.94 1.00	0.93 1.00	0.92 1.00	0.91 1.00	0.90 0.99	0.90 0.99	0.90 0.99	0.90 0.99	0.89 0.99	0.89 0.99	0.88 0.98	0.88 0.98	0.88 0.98
0.89 0.94	0.87 0.86	0.85 0.50											
0.83 0.95	0.80 0.81	0.78 0.60											
0.84 0.97	0.82 0.93	0.80 0.76	0.79 0.55										
0.85 0.97	0.82 0.96	0.80 0.91	0.79 0.80	0.78 0.60									
0.90 0.99	0.89 0.98	0.88 0.95	0.88 0.86	0.88 0.62									
0.93 0.99	0.91 0.98	0.90 0.98	0.90 0.96	0.90 0.95	0.90 0.90	0.90 0.75	0.89 0.50						

## Maintenance of lighting systems

### Lamp luminous flux maintenance factor (LLMF) and lamp survival factor (LSF)

Lamps		Service life given in hours					
		100	500	1000	1500	2000	4000
<b>Metal halide lamp Ceramic (50–150 W)</b> CIE97:2005	LLMF	1.00	0.95	0.87		0.75	0.72
	LSF	1.00	0.99	0.99		0.98	0.98
<b>Metal halide lamp Ceramic</b> Philips CDM-T 70 W/Elite	LLMF	1.00	0.99	0.98	0.96	0.95	0.91
	LSF	1.00	1.00	1.00	1.00	1.00	1.00
<b>Metal halide lamp Ceramic</b> Osram HCI-T 150 W/WDL PB	LLMF	1.00	0.93	0.88	0.87	0.86	0.80
	LSF	1.00	1.00	1.00	1.00	0.99	0.99
<b>Metal halide lamp Ceramic</b> Osram HCI 250 W PB	LLMF	1.00	0.96	0.92	0.91	0.90	0.87
	LSF	1.00	0.99	0.98	0.98	0.97	0.94
<b>Metal halide lamp Quartz (250/400 W)</b> CIE97:2005	LLMF	1.00	0.98	0.95		0.90	0.87
	LSF	1.00	0.99	0.99		0.98	0.97
<b>Metal halide lamp Quartz</b> Osram HQI-E 250 W/D	LLMF	0.99	0.98	0.92	0.88	0.85	0.80
	LSF	1.00	0.99	0.98	0.97	0.95	0.91
<b>Metal halide lamp Quartz</b> Osram HQI-E 400 W/D	LLMF	1.00	0.97	0.93	0.88	0.85	0.80
	LSF	1.00	0.99	0.98	0.97	0.95	0.91
<b>Metal halide lamp Quartz</b> Osram HQI-BT 400 W/N	LLMF	1.00	0.97	0.92	0.87	0.83	0.77
	LSF	1.00	0.99	0.98	0.97	0.95	0.91
<b>Metal halide lamp Quartz</b> Philips HPI-T Plus 250/400 W	LLMF	1.00	0.98	0.96	0.93	0.92	0.86
	LSF	1.00	1.00	0.99	0.99	0.99	0.98
<b>Sodium vapour lamp 50/70 W</b> ZVEI 2005	LLMF	1.00	0.99	0.98	0.97	0.96	0.93
	LSF	1.00	1.00	0.99	0.99	0.98	0.97
<b>Sodium vapour lamp 150–400 W (standard lum. flux level)</b> ZVEI 2005	LLMF	1.00	0.99	0.98	0.97	0.96	0.93
	LSF	1.00	1.00	0.99	0.98	0.98	0.97
<b>Sodium vapour lamp 150–400 W (increased lum. flux level)</b> ZVEI 2005	LLMF	1.00	0.99	0.99	0.98	0.97	0.96
	LSF	1.00	1.00	1.00	1.00	0.99	0.98
<b>Sodium vapour lamp</b> Philips SON-(T) PIA Plus 100–400 W	LLMF	1.00	0.99	0.99	0.98	0.98	0.97
	LSF	1.00	1.00	1.00	1.00	1.00	1.00

Values acc. to specifications by lamp manufacturers, January 2008, acc. to CIE97:2005

Technical report "Guide on the Maintenance of Indoor Electric Lighting Systems" 2nd edition, and ZVEI publication "Service life behaviour of discharge lamps for lighting" of November 2005.

For data of lamps by other manufacturers or other lamp types, please contact the respective manufacturer directly.

The use of state-of-the-art ballast technology is a prerequisite.

The switching frequency has a major influence on lamp survival.

Most data are based on the standardised 3-hour switching rhythm acc. to IEC (2.75 h ON, 0.25 h OFF).

6000	8000	10000	12000	14000	16000	18000	20000	22000	24000	30000	35000	40000	45000
0.68	0.64	0.60	0.56										
0.98	0.95	0.80	0.50										
0.87	0.85	0.81	0.80										
1.00	0.98	0.90	0.50										
0.77	0.73	0.71	0.69										
0.98	0.96	0.88	0.70										
0.84	0.81	0.80	0.75										
0.90	0.85	0.75	0.62										
0.83	0.79	0.65	0.63	0.60	0.56	0.53	0.50						
0.92	0.86	0.80	0.73	0.68	0.63	0.55	0.50						
0.75	0.70	0.69	0.65										
0.86	0.79	0.70	0.61										
0.78	0.74	0.71	0.69										
0.86	0.79	0.70	0.61										
0.73	0.72	0.70	0.69										
0.86	0.79	0.70	0.61										
0.83	0.80	0.78	0.76	0.74	0.73	0.72	0.71						
0.96	0.93	0.89	0.84	0.75	0.66	0.59	0.50						
0.90	0.89	0.88	0.88	0.87	0.87	0.87	0.86	0.85					
0.96	0.93	0.92	0.89	0.84	0.79	0.72	0.63	0.50					
0.92	0.91	0.90	0.89	0.88	0.88	0.88	0.88	0.87	0.87				
0.97	0.96	0.95	0.93	0.92	0.90	0.88	0.84	0.79	0.70				
0.95	0.94	0.93	0.92	0.92	0.91	0.91	0.90	0.90	0.90				
0.98	0.97	0.97	0.95	0.93	0.92	0.90	0.86	0.81	0.73				
0.97	0.96	0.95	0.95	0.94	0.94	0.93	0.93	0.92	0.92	0.90	0.89		
0.99	0.98	0.97	0.96	0.93	0.92	0.88	0.86	0.82	0.77	0.55	0.43		

## Maintenance of lighting systems

### Lamp luminous flux maintenance factor (LLMF) and lamp survival factor (LSF)

LED luminous flux classes* with the following specific values		Service life given in hours							
		1000	5000	10000	15000	20000	25000	30000	35000***
L95 @ 50000 h	LLMF	1.00	1.00	0.99	0.99	0.98	0.98	0.97	0.97
	LSF	1.00	1.00	1.00	1.00	1.00	1.00	1.00	1.00
L90 @ 50000 h	LLMF	1.00	0.99	0.98	0.97	0.96	0.95	0.94	0.93
	LSF	1.00	1.00	1.00	1.00	1.00	1.00	1.00	1.00
L85 @ 50000 h	LLMF	1.00	0.99	0.97	0.96	0.94	0.93	0.91	0.90***
	LSF	1.00	1.00	1.00	1.00	1.00	1.00	1.00	1.00
L80 @ 50000 h	LLMF	1.00	0.98	0.96	0.94	0.92	0.90	0.88	0.86
	LSF	1.00	1.00	1.00	1.00	1.00	1.00	1.00	1.00
L75 @ 50000 h	LLMF	1.00	0.98	0.95	0.93	0.90	0.88	0.85	0.83
	LSF	1.00	1.00	1.00	1.00	1.00	1.00	1.00	1.00
L70 @ 50000 h	LLMF	0.99	0.97	0.94	0.91	0.88	0.85	0.82	0.79
	LSF	1.00	1.00	1.00	1.00	1.00	1.00	1.00	1.00
L65 @ 50000 h	LLMF	0.99	0.97	0.93	0.90	0.86	0.83	0.79	0.76
	LSF	1.00	1.00	1.00	1.00	1.00	1.00	1.00	1.00
L60 @ 50000 h	LLMF	0.99	0.96	0.92	0.88	0.84	0.80	0.76	0.72
	LSF	1.00	1.00	1.00	1.00	1.00	1.00	1.00	1.00
L55 @ 50000 h	LLMF	0.99	0.96	0.91	0.87	0.82	0.78	0.73	0.69
	LSF	1.00	1.00	1.00	1.00	1.00	1.00	1.00	1.00
L50 @ 50000 h	LLMF	0.99	0.95	0.90	0.85	0.80	0.75	0.70	0.65
	LSF	1.00	1.00	1.00	1.00	1.00	1.00	1.00	1.00

\* An LED luminous flux class is characterised by the useful service life L<sub>x</sub> (basis selected: 50000 h) at a drop in luminous flux to x% (initial level = 100%) and an ambient temperature of 25 °C.  
Example: the LED luminous flux class at "L80 @ 50000 h" describes a drop in luminous flux to 80% (LLMF = 0.80) at a useful service life of 50000 h.

The maintenance factor values specified for an LED luminous flux class are intended to facilitate planning. They provide a non-binding indication of the prospective luminous flux changes over the course of time, assuming a linear reduction in luminous flux.

The maintenance factors for an assumed service life are available for planning purposes.

Please note: the known lamp maintenance factors LLMF and LSF are applied to LED modules, although these are not lamps in the proper meaning of the term. LSF is assumed to be 1, as a total breakdown of the complete LED module can be neglected for planning purposes.

The values comply with international standards IEC 62717 and IEC 62722.

40 000	45 000	50 000	55 000	60 000	65 000	70 000	75 000**	80 000	85 000	90 000	95 000	100 000
0.96 1.00	0.96 1.00	0.95 1.00	0.95 1.00	0.94 1.00	0.94 1.00	0.93 1.00	0.93 1.00	0.92 1.00	0.92 1.00	0.91 1.00	0.91 1.00	0.90 1.00
0.92 1.00	0.91 1.00	0.90 1.00	0.89 1.00	0.88 1.00	0.87 1.00	0.86 1.00	0.85 1.00	0.84 1.00	0.83 1.00	0.82 1.00	0.81 1.00	0.80 1.00
0.88 1.00	0.87 1.00	0.85*** 1.00	0.84 1.00	0.82 1.00	0.81 1.00	0.79 1.00	0.78 1.00	0.76 1.00	0.75 1.00	0.74 1.00	0.72 1.00	0.70 1.00
0.84 1.00	0.82 1.00	0.80** 1.00	0.78 1.00	0.76 1.00	0.74 1.00	0.72 1.00	0.70** 1.00	0.68 1.00	0.66 1.00	0.64 1.00	0.62 1.00	0.60 1.00
0.80 1.00	0.78 1.00	0.75 1.00	0.73 1.00	0.70 1.00	0.68 1.00	0.65 1.00	0.63 1.00					
0.76 1.00	0.73 1.00	0.70 1.00	0.67 1.00	0.64 1.00	0.61 1.00	0.58 1.00	0.55 1.00					
0.72 1.00	0.69 1.00	0.65 1.00	0.62 1.00	0.58 1.00								
0.68 1.00	0.64 1.00	0.60 1.00	0.56 1.00	0.52 1.00								
0.64 1.00	0.60 1.00	0.55 1.00										
0.60 1.00	0.55 1.00	0.50 1.00										

LED luminaires can be compared by finding the matching "LLMF and service life" pair of values for the "Lx @ 50 000 h" class in the same line, with LLMF x 100 corresponding to the luminous flux component (in %).

Example:

\*\* L80 @ 50 000 h corresponds to L70 @ 75 000 h

\*\*\* L90 @ 35 000 h corresponds to L85 @ 50 000 h

## Maintenance of lighting systems

### Table for luminaire maintenance factor (LMF)

Luminaire cleaning interval in years	0.5				1.0					
	VC	C	N	S	VC	C	N	S	VC	C
<b>Luminaire type</b>										
<b>Luminaire type</b>										
Batten lum. with open light distribution	0.98	0.95	0.92	0.88	0.96	0.93	0.89	0.83	0.95	0.91
Reflector exposed above (self-cleaning effect)	0.96	0.95	0.91	0.88	0.95	0.90	0.86	0.83	0.94	0.87
Reflector enclosed above (no self-cleaning effect)	0.95	0.93	0.89	0.83	0.94	0.89	0.81	0.72	0.93	0.84
Enclosed IP2X	0.94	0.92	0.87	0.83	0.94	0.88	0.82	0.77	0.93	0.85
Dust-proof IP5X	0.94	0.96	0.93	0.91	0.96	0.94	0.90	0.86	0.92	0.92
Indirect luminaires	0.94	0.92	0.89	0.85	0.93	0.86	0.81	0.74	0.91	0.81

From CIE publication 97 "Maintenance of indoor electric lighting systems", dated 2005, ICBN 390073434 8

**Ambient conditions: VC = very clean, C = clean, N = normal, S = soiled**

### Table for room maintenance factor (RMF)

Luminaire cleaning interval in years	Illumination type	Environment type	0	0.5	1.0	1.5
<b>Direct</b>		<b>VC</b>	1.00	0.98	0.97	0.97
		<b>C</b>	1.00	0.96	0.95	0.94
		<b>N</b>	1.00	0.92	0.91	0.90
		<b>S</b>	1.00	0.87	0.86	0.86
<b>Direct/Indirect</b>		<b>VC</b>	1.00	0.97	0.96	0.95
		<b>C</b>	1.00	0.93	0.91	0.91
		<b>N</b>	1.00	0.87	0.84	0.84
		<b>S</b>	1.00	0.77	0.75	0.75
<b>Indirect</b>		<b>VC</b>	1.00	0.95	0.93	0.92
		<b>C</b>	1.00	0.89	0.86	0.85
		<b>N</b>	1.00	0.77	0.73	0.72
		<b>S</b>	1.00	0.60	0.56	0.55

From CIE publication 97 "Maintenance of indoor electric lighting systems", dated 2005, ISBN 390073434 8

The figures in the table above apply to reflection factors 70/50/20 and a medium-sized room (k = 2.5)

**Ambient conditions: VC = very clean, C = clean, N = normal, S = soiled**

1.5			2.0				2.5				3.0			
N	S	VC	C	N	S	VC	C	N	S	VC	C	N	S	
0.87	0.80	0.94	0.89	0.84	0.78	0.93	0.87	0.82	0.75	0.92	0.85	0.79	0.73	
0.83	0.79	0.92	0.84	0.80	0.75	0.91	0.82	0.76	0.71	0.87	0.79	0.74	0.68	
0.74	0.64	0.91	0.80	0.69	0.59	0.89	0.77	0.64	0.84	0.87	0.74	0.61	0.52	
0.79	0.73	0.91	0.83	0.77	0.71	0.90	0.81	0.75	0.68	0.89	0.79	0.73	0.65	
0.88	0.83	0.93	0.91	0.86	0.81	0.92	0.90	0.85	0.80	0.92	0.90	0.84	0.79	
0.73	0.65	0.77	0.88	0.66	0.57	0.86	0.73	0.60	0.51	0.85	0.70	0.55	0.45	

2.0	2.5	3.0	3.5	4.0	4.5	5.0	5.5	6.0
0.97	0.97	0.97	0.97	0.97	0.97	0.97	0.97	0.97
0.94	0.94	0.94	0.94	0.94	0.94	0.94	0.94	0.94
0.90	0.90	0.90	0.90	0.90	0.90	0.90	0.90	0.90
0.86	0.86	0.86	0.86	0.86	0.86	0.86	0.86	0.86
0.95	0.95	0.95	0.95	0.95	0.95	0.95	0.95	0.95
0.91	0.91	0.91	0.91	0.91	0.91	0.91	0.91	0.91
0.83	0.83	0.83	0.83	0.83	0.83	0.83	0.83	0.83
0.75	0.75	0.75	0.75	0.75	0.75	0.75	0.75	0.75
0.92	0.92	0.92	0.92	0.92	0.92	0.92	0.92	0.92
0.84	0.84	0.84	0.84	0.84	0.84	0.84	0.84	0.84
0.72	0.72	0.72	0.72	0.72	0.72	0.72	0.72	0.72
0.55	0.55	0.55	0.55	0.55	0.55	0.55	0.55	0.55

## Maintenance of lighting systems

### Table of burning hours

Working mode/ shift type	Switch-on period Days in use/year	Hours/day	Daylight-based control	Burning hours per lamp and year in hours
24-h shift working, Process monitoring/ control	365	24 h	No	8760 h
	365	24 h	Yes	7300 h
Double shift, 6 days/week	310	16 h	No	4960 h
	310	16 h	Yes	3720 h
Single shift, 6 days/week	310	10 h	No	3100 h
	310	10 h	Yes	1760 h
Single shift, 5 days/week	258	10 h	No	2580 h
	258	10 h	Yes	1550 h

Daylight-based control: the lamps switch on automatically when there is too little daylight available.

Data is based on the assumption that there is sufficient available daylight for half the year.

From CIE publication 97 "Maintenance of indoor electric lighting systems", dated 2005



## Design tools

<b>Design process and tools</b>		207
<b>Checklists</b>		
	General information – The five steps of lighting design	208
	General information – Refurbishment of lighting systems	211
<b>Programs</b>		
	VIVALDI	214
	VIVALDI facade	216
	LM Energy	218
	ecoCALC	219
<b>Online design tools</b>		
	QuickCalc	220
	QuickCalc Mobile	221
	ecoCALC light	222
	DALEC	223
<b>Online product information</b>		
	Online catalogue	224
	Mobile online catalogue	225
	QR code	226
	Product data sheets and installation instructions	227
	2D CAD data: DWG, DXF	228
	3D CAD data: REVIT, ARCHICAD	228
	Environmental product declaration (EPD)	229
<b>Map of Light</b>		230



## Design process and tools

### Design process

#### Communication

Attention to products and concepts



#### Requirement

Define requirements, determine basic situation



#### Planning

**Blueprint planning:** work out a concept  
**Detailed planning:** calculation, optimise  
**Documentation**



#### Implementation

Implementation, testing, maintenance

### Design tools

#### Communication

Product catalogue, brochures, Map of Light, ads and press work, trade fairs, conferences, events, roadshows, Light Forums



#### Requirement

Research projects, studies, DALEC



#### Planning

Online catalogue, QuickCalc, system configurators, LM Energy, DIALux, Relux, ecoCALC, VIVALDI visualisation

## Checklists

General information – The five steps of lighting design

**The five steps of lighting design = help for structuring the lighting design scheme**

- Determine lighting REQUIREMENTS
- SELECT lamps, luminaires and lighting management
- Calculate NUMBER of luminaires required
- POSITION luminaires and lighting control
- ANALYSE the results

From experience we know that usually Step 1 = Determine lighting requirements, is not taken into account sufficiently.

The checklist below should help the user to consider key questions for clarifying basic requirements.

Understanding this task will allow for proper development of a well thought-out lighting solution based on the quality characteristics of lighting (page 12) and project-specific requirements.

## Requirements placed on lighting

checked ✓

### *Underlying conditions*

Utilisation of rooms	<input type="checkbox"/>
Size and height of room	<input type="checkbox"/>
Ceiling structure	<input type="checkbox"/>
Reflection factors	<input type="checkbox"/>
Window areas	<input type="checkbox"/>
Doors, passageways, circulation areas	<input type="checkbox"/>
Multi-task areas	<input type="checkbox"/>
Arrangement and material of furniture	<input type="checkbox"/>
Protection types (foreign bodies and humidity)	<input type="checkbox"/>
Protection classes (electrical installations)	<input type="checkbox"/>
Influence by chemicals	<input type="checkbox"/>
Fire protection	<input type="checkbox"/>
Emergency lighting	<input type="checkbox"/>
Energy consumption limits (kWh/year)	<input type="checkbox"/>
Maximum power requirement (W/m <sup>2</sup> )	<input type="checkbox"/>
Budget for initial installation	<input type="checkbox"/>

**Checklists****Selection of lamps, luminaires and lighting management**

checked ✓

Lamp type

Luminaire range and model

Lighting management range and modules

**Calculate number of luminaires required**

Rough calculation (Quickplan/Quickcalc)

Detailed calculation (Dialux/Relux)

Planning conditions (maintenance, reflection)

**Positioning of luminaires and lighting control**

Structural situation

Orientation (avoid reflections and glare)

Spacings between luminaires (regular patterns)

Peripheries

Alignment

Technical infrastructure (distribution cabinet, clamping compartment, ...)

Position of control gear

Emergency lighting

## General information – Refurbishment of lighting systems

The following list provides clues for discussion with the customer. The potentials stated draw a comparison between contemporary lighting solution options available today with the technology approx. 15 years ago. In a project, viable savings must be accurately calculated in the design stage. The savings apply only on a case-by-case basis. If several measures are taken, they will complement each other without the levels adding up.

### 1. Saving energy, CO<sub>2</sub> and costs

	<b>Potential savings</b>
<b>1. Advanced materials</b> Today's reflectors and innovative surface finishes provide for more efficient luminaires.	up to -30%
<b>2. Use of daylight</b> The LUXMATE daylight-based lighting control system provides for high energy savings where sufficient daylight is available.	up to -60%
<b>3. Improvement of lamps and control gear</b> Innovations in the electronic control of lamps, optimised temperatures and improvements of the lamps' physical properties provide for extensive savings.	up to -40%
<b>4. Taking ageing into account</b> The balance between the new value and minimum illuminance can be saved by dimmable control (Maintenance Control).	up to -17%
<b>5. Taking room utilisation into account</b> Using presence detectors or a time-based control system, the lighting can be adjusted precisely to the time/s of use.	up to -25%

## Checklists

**2. Improved ergonomic compatibility**

	<b>Potential savings</b>
<p><b>1. Increased productivity</b></p> <p>According to various studies, an individual's productivity can be significantly improved by an upgraded lighting solution (e.g. research by TU Ilmenau, AIF no. 9955).</p>	↗
<p><b>2. Fewer errors</b></p> <p>According to various studies, people's error rate can be minimised by an upgraded lighting solution (e.g. research by TU Ilmenau, AIF no. 9955).</p>	↗
<p><b>3. Increased alertness</b></p> <p>The human physiology is decoded step-by-step, allowing to perfectly adjust the lighting to the individual (e.g. doctoral thesis by Susanne Fleischer, ETH Zürich).</p>	↗
<p><b>4. Enhanced sense of wellbeing</b></p> <p>Pleasant brightness levels and personal control can have a positive impact on an individual's sense of wellbeing (e.g. Light Right Consortium).</p>	↗

Please note: It is difficult to provide exact and generally applicable figures; however, measurable increases were achieved in individual cases. Minor increases already result in high economic benefits.



### 3. Improved maintenance conditions

(employment of staff for cleaning, maintenance and monitoring)

	<b>Potential savings</b>
<b>1. Extension of maintenance cycle</b> Over recent years, the service life of lamps has been significantly extended.	up to +50%
<b>2. Reduction in maintenance costs</b> Contemporary luminaires frequently come in a closed design, allowing for easy cleaning.	up to -30%
<b>3. Automatic monitoring of installations</b> Today, the facility management tools allow for automatic, central monitoring of installations. The service life of modern light sources, particularly that of LED, is significantly increased.	up to -80%
<b>4. Energy savings</b> Easy cleaning luminaires and extension of the maintenance cycle result in a reduced number of luminaires required, and thus energy savings.	up to -20%

### 4. Additional arguments

#### 1. Improvements in environmental factors

Today, WEEE and RoHS provide the basis for manufacturing luminaires. Environmental impact has been reduced (e.g. lead/cadmium).

#### 2. State-of-the-art

The latest lighting solutions reflect the state-of-the-art and an improved situation in terms of lighting standards.

## Programs

### VIVALDI

VIVALDI is our interactive tool for designing lighting scenes and designing dynamic lighting concepts.

- VIVALDI uses sketches or images from lighting calculation programs
- Individual light sources can be intuitively controlled in intensity and colour using sliders
- As regards images from calculation programs, details on illuminance and luminance levels as well as on energy consumption are given in real time
- Changes in lighting scenes are displayed in real time
- Dynamic sequences within the scenes are interactively controlled via timelines
- Daylight sequences can be taken into account so that daylight and artificial lighting can be dynamically adjusted over the course of the day

### Visualisations that let you experience light

In the presentation with VIVALDI, customers can see at a glance how the different colour temperatures -matched to the daylight curve have a positive effect on the office ambience. Using the controllers and detailed settings available in VIVALDI, the the presentation can be interactively changed and adjusted at any time. Substantial potential savings are possible if the solution is not operated constantly at 100 % and the luminaires are assigned dimming curves in the course of the day.



For more information and downloads, please refer to:  
[zumtobel.com/com-en/service.html#programs](http://zumtobel.com/com-en/service.html#programs)

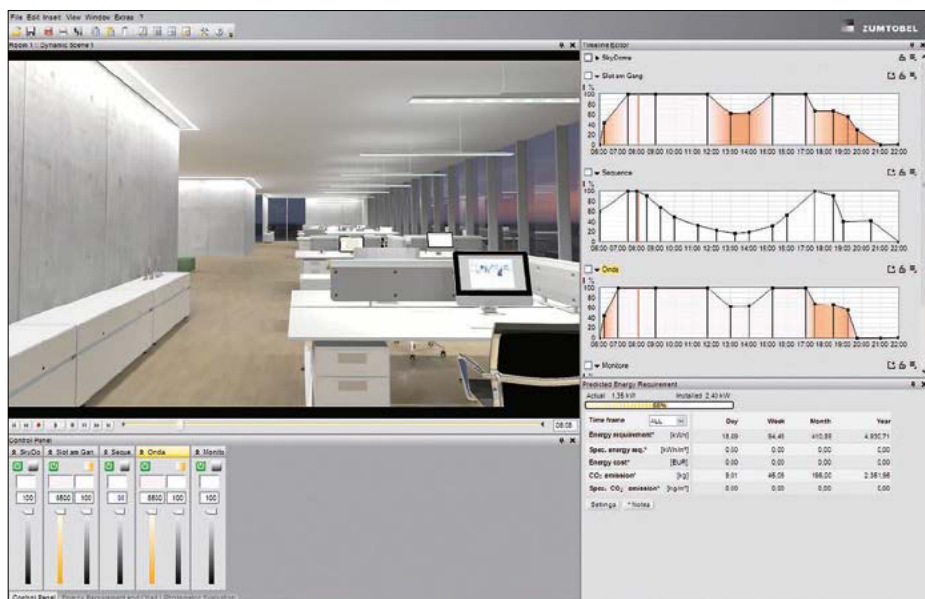

VIVALDI simulation: a cold-white lighting scene with high luminous intensities helps wake up employees.



A lot of daylight enters through the windows during the day. VIVALDI calculates the potential savings achieved by dimming the luminaires.

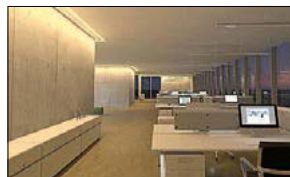

Warm-white light colours and reduced luminous intensities in the evening help stabilise the natural day-night rhythm.

## Programs

### VIVALDI facade

#### Visualisation on the basis of a photo

A new VIVALDI module allows rapid and easy design of outdoor lighting concepts. This is based on a photo of a facade or an aerial photo. Once an image has been imported to VIVALDI, luminaires can be dragged onto the facade directly from the online product catalogue and arranged as desired. The light distribution of the luminaire is then shown in the photo. The luminaires can be dimmed or the light colour changed with sliders and it is even possible to create dynamic processes with timelines. VIVALDI hereby always keeps an eye on the solution's energy consumption.

You can download VIVALDI for free from

**[zumtobel.com/VIVALDI](http://zumtobel.com/VIVALDI)**

Its use is explained in short video tutorials that are available via the help function.



For more information and downloads, please refer to:  
**[zumtobel.com/com-en/service.html#programs](http://zumtobel.com/com-en/service.html#programs)**



## Programme

### LM Energy

The “LM Energy” program calculates the energy-saving potential to be expected for interior lighting controlled by daylight-based lighting management systems.

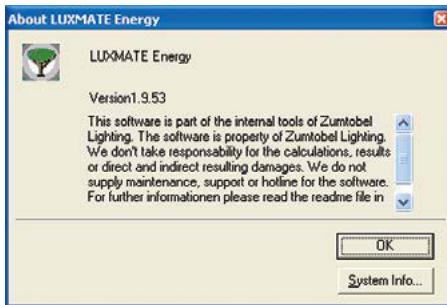

For more information, please refer to [zumtobel.com/com-en/service.html#programs](http://zumtobel.com/com-en/service.html#programs)

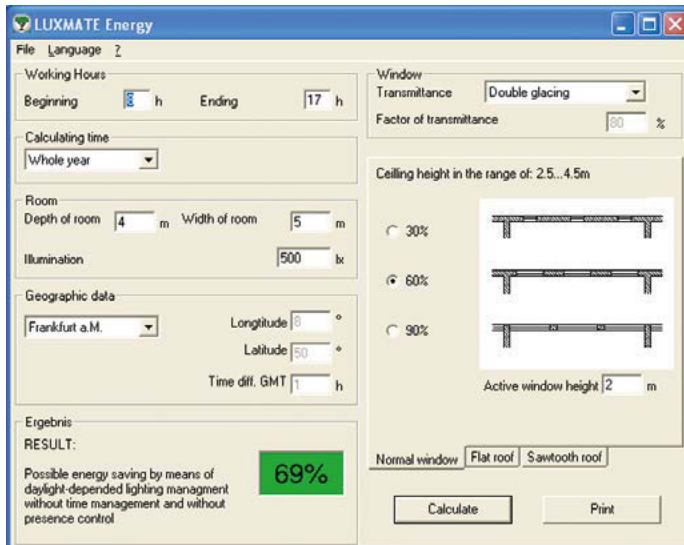

## ecoCALC

ecoCALC is Zumtobel's tool for analysing the costs of a lighting solution throughout its service life.

- Maintenance cycles and the dimensions of the lighting solution are optimised so that lighting quality will be guaranteed at all times with maximum cost efficiency.
- Evaluation of static or dynamically controlled lighting solutions with individual timelines for all luminaires
- A variety of utilisation and control scenarios over the course of a year can be evaluated
- Database including defined dimming characteristics and details regarding lamp and ballast changes throughout their service life
- Variable electricity rates and rise in electricity rates can be defined
- Existing installations can be analysed and all luminaires – independent of the manufacturer – can be entered
- Easy to operate and control thanks to wizard mode



For more information and downloads, please refer to: [zumtobel.com/com-en/service.html#programs](http://zumtobel.com/com-en/service.html#programs)



## Online design tools

### QuickCalc

QuickCalc provides a quick, approximate determination of the number of luminaires required to achieve a defined illuminance level according to the light output ratio method – or vice versa: to determine the illuminance level necessary for a defined number of luminaires.

In the Zumtobel online catalogue, QuickCalc is available for products with calculation data under the “QuickCalc” tab.

**ZUMTOBEL**  
Go to product family MELLOW LIGHT V

MLS EH 39W LED33 MODEL LDE TBL Article no. 42 188 981

CONFIGURE PRODUCT

OVERVIEW DATA SHEET PHOTOMETRY **QUICKCALC** DOWNLOADS

QuickCalc Help Display result as pdf Print view

**Luminaire**  
Luminaire model: MLS EH 39W LED33 MODEL LDE TBL

Luminaire type: 2x300 mm Dimming level: 150 %  
Length of pendant: 0.08 m Height above WP: 2.19 m

**Room**  
Name:   
Length/Width/Height:  3.00 m  3.00 m  3.00 m  
Working plane (WP): 0.75 m  
Maintenance factor: 0.87  
Reflector factor: T95020 Ceiling/Work floor in %

**Result**  
Illuminance: 547 lx No. of Luminaires: 12  
Spec. Connected load: 11.70W/m<sup>2</sup> 2.14W/m<sup>2</sup>/100lx  
Rows: 6  
Columns: 2

**Description**

**Product description**  
Picture  
Product description  
Brochure

**Design data**  
Photometric LDT  
Photometric IES  
Transfer to QuickCalc  
Transfer to DALI.us  
Transfer to Relay  
Calculator  
Photometric Data sheet  
Declaration of Conformity  
3D CAD drawing  
3D CAD drawing  
3D BIM Revit file

**Handling**  
Dimensional sketch  
Installation  
Installation

Select all  
Reset  
Description PDF

You find QuickCalc at the respective product under:  
**zumtobel.com/com-en/products**



## QuickCalc Mobile

The mobile version of QuickCalc makes this intuitive lighting calculation program available at any time, anywhere.

This tried-and-tested program by Zumtobel has been optimised for mobile terminal devices, ensuring that users can now make rough calculations not only at the office, but also directly at the construction site.

Based on product data available in the mobile e-catalogue, QuickCalc Mobile needs just a few steps to calculate how many luminaires are required to achieve the necessary illuminance level at a given room size.

For any number of luminaires specified, the program will calculate the illuminance level that can be achieved.

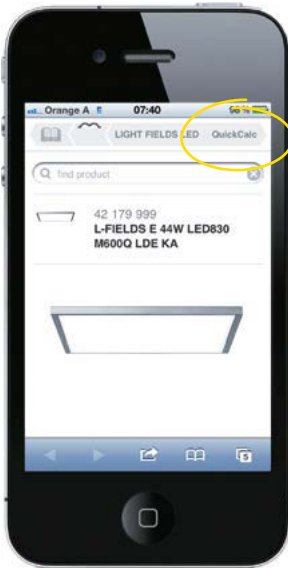

The calculation program opens as soon as you click the QuickCalc icon in the online product catalogue.



Now enter the length, width and height of the room.



The number of luminaires required will now be calculated, and a PDF file can be created from the calculation.

## Online design tools

### ecoCALC light

#### Light enough for the cloud

ecoCALC light can compare up to three simple lighting solutions online and all necessary inputs can be made on one page.

Results can be achieved with so few entries because ecoCALC light works with the product data from the online catalogue, calculates maintenance intervals automatically and saves typical settings as default values.

The unique features of ecoCALC are therefore retained and a luminous intensity curve can still be output, for example, whilst maintenance costs are calculated with regard to the manufacturer's data for the lamps and luminaires. A selection of typical existing luminaires is also provided.

The luminous intensity can also be calculated directly in ecoCALC light because we integrate the familiar QuickCalc from the product pages into the application. This way it can be ensured that the solutions really are comparable.

All of the results can then be shown on a single page and it is of course possible to enlarge graphics and generate a printout. But the most important thing is that you can share your project with colleagues or customers by simply sending them a link – no installation is necessary.

[ecocalight.zumtobel.com/app/#/](http://ecocalight.zumtobel.com/app/#/)

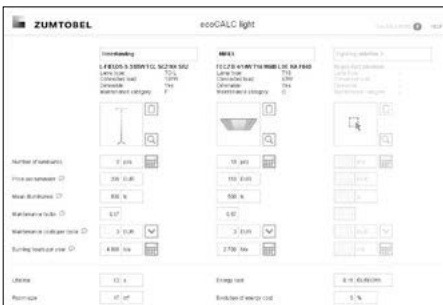

## DALEC

### Day- and Artificial Light with Energy Calculation

#### Concept analysis tool for comprehensive lighting planning

DALEC is a design tool to determine potential savings for rooms with day and artificial lighting systems. It was developed within the scope of the K-light research project “Integrated Day and Artificial Light”, which looked into an integral control approach for facade systems. The DALEC web application is the result of a research partnership with the University of Innsbruck, Bartenbach and Zumtobel Lighting. DALEC is an easy-to-use tool for determining energy saving potential in rooms with daylight and artificial light systems in early project phases. It evaluates different facade and artificial light solutions and determines their influence on heating and cooling loads. Quality criteria such as room temperature or glare control are also evaluated at the same time.

DALEC has been implemented as an online service and is available at [dalec.zumtobel.com](http://dalec.zumtobel.com)

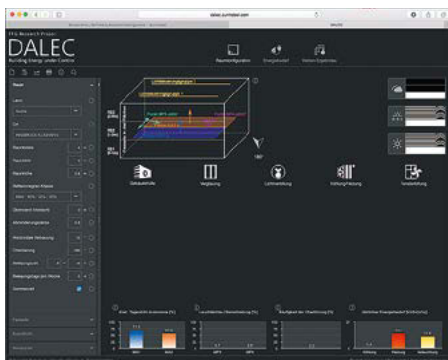

## Online product information

### Online catalogue

Under the “Download” tab, the online catalogue provides a list of all product data available for a specific product.

Available product information:

- Product data sheet incl. maintenance category
- Photometric data sheets incl. UGR tables
- Photometric data formats Eulumdat, IES
- Drag & drop data for DIALux and Relux
- Brochures
- Installation instructions
- CE certificates
- 3D BIM Revit file
- CAD data: 2D and 3D
- Environmental product declaration (EPD)
- Data for automatic circuit breakers
- Label according to EU-VO 874/2012

**ZUMTOBEL**

LFE A LED3000-430 L12 LDO SRE Article no. 42 184 801

Print view

OVERVIEW DATA SHEET PHOTOMETRY QUICKCALC DOWNLOADS

**OVERVIEW**

**PRODUCT DATA**

Description	LFE A LED3000-430 L12 LDO SRE
Article no.	42 184 801
EAN number	9008709871281
Light Source	LED
Luminaire luminous flux*	3650 lm
Luminaire efficacy*	117 lm/W
Colour Rendering Index min.	80
Ballast	1 x 38520005 DRV 7R LCA 50W 1.05A-50V D #DAA to PFE
Miniature circuit breaker	quantity with 816: 21 pcs.
Correlated colour temperature*	3000 Kelvin
Chromaticity tolerance (initial MacAdams)*	3
Rated median useful life*	50000h L90 at 25°C
Luminaire input power*	31.3 W Lambda = 0.96
Standby Power*	0.5 W
Dimming	LDO dimmable to 1% over DALI

80°C

**Product description**

- Product Description
- Brochure

**Design data**

- Photometric LDT
- Photometric IES
- Transfer to IESCALC, VIVALDI, DALI2 or HSLITE
- Transfer to DIALux
- Transfer to Relux
- Family datasheet
- Datasheet
- Photometric Database
- Combination Database
- Circuit breaker data
- Label acc. EU Reg. 874/2012
- Test mark certificate
- CE - Declaration of Conformity
- ENEC certificate
- RoHS Declaration of Conformity
- 3D-CAD drawing
- 3D-CAD drawing

**Handling**

- Dimensional sketch
- Dimensional sketch
- Installation Instruction

Select all  
Reset  
Go back to top

Quick access with  
URL/article reference:  
**zumtobel.com/42184801**

## Mobile online catalogue

Zumtobel's online product catalogue has been optimised for access via mobile devices, enabling users to directly access information on the complete product range anywhere and at any time, by means of smart phones and tablets.

To this end, all you need to do is go to **<http://mobile.zumtobel.com>** (or the page of the respective country, e.g. <http://mobile.zumtobel.co.uk>) via the mobile device's browser. As this is not an app, no software needs to be installed, and access is possible from various devices.

The system supports iPhones, iPads as well as Android-based mobile phones and tablets. Access is, however, also possible using Blackberry devices OS 6 and higher, as well as other current smart phones, such as the Nokia S60, for instance.

In the mobile version, too, products can be accessed directly via a quicklink. To do so, all you need to do is enter <http://mobile.zumtobel.com> followed by the respective order number

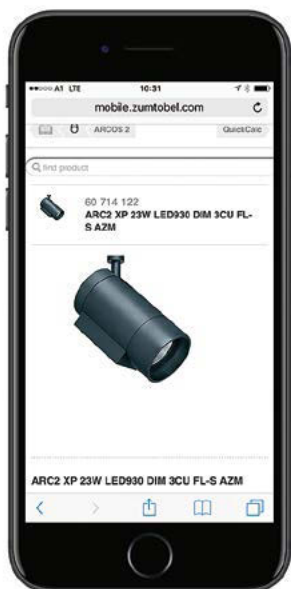

For article number 60714122,  
for example, this would be:  
**<http://mobile.zumtobel.com/60714122>**

## Online product information

### QR code

A so-called QR (Quick Response) code is printed on all cardboard packaging for Zumtobel luminaires of the standard range. This code is similar to a bar code and makes it easy to quickly access information on a specific product, even when you are not at the office.

If you have installed free QR reading software on your smart phone, all you need to do is focus your mobile phone's camera onto this black-and-white square; you will

then be automatically directed to the respective product in Zumtobel's online catalogue.

All information available on the product, such as installation instructions, data sheets and product details, can be conveniently retrieved from the product catalogue. In order to make it really easy to navigate the catalogue using a mobile phone as well, the whole online catalogue has been optimised for mobile devices.



## Product data sheets and installation instructions

Any product information required can be selected from the online catalogue and summarised in the form of a data sheet. Additionally, all installation instructions for the respective product are available in PDF format. See description of the data sheet in chapter 4, page 70.

- Complete product information in PDF format, up to date and country-specific: figures, charts, images
- Compilation of the product information selected in the form of a data sheet (ZIP file)
- Photometric data sheets
- Data sheets with connecting instructions for LUXMATE products
- Quick dispatch of any part of the catalogue by e-mail

For more product information, please refer to: [zumtobel.com/com-en/products](http://zumtobel.com/com-en/products)

Model	H	B	L	W
1. CLEAN Supreme 2/28-54	28	94	84	0.10
2. CLEAN Supreme 2/28-54	28	94	84	0.10
3. CLEAN Supreme 2/28-54	28	94	84	0.10
4. CLEAN Supreme 2/28-54	28	94	84	0.10
5. CLEAN Supreme 2/28-54	28	94	84	0.10
6. CLEAN Supreme 2/28-54	28	94	84	0.10
7. CLEAN Supreme 2/28-54	28	94	84	0.10
8. CLEAN Supreme 2/28-54	28	94	84	0.10
9. CLEAN Supreme 2/28-54	28	94	84	0.10
10. CLEAN Supreme 2/28-54	28	94	84	0.10
11. CLEAN Supreme 2/28-54	28	94	84	0.10
12. CLEAN Supreme 2/28-54	28	94	84	0.10
13. CLEAN Supreme 2/28-54	28	94	84	0.10
14. CLEAN Supreme 2/28-54	28	94	84	0.10
15. CLEAN Supreme 2/28-54	28	94	84	0.10
16. CLEAN Supreme 2/28-54	28	94	84	0.10
17. CLEAN Supreme 2/28-54	28	94	84	0.10
18. CLEAN Supreme 2/28-54	28	94	84	0.10
19. CLEAN Supreme 2/28-54	28	94	84	0.10
20. CLEAN Supreme 2/28-54	28	94	84	0.10
21. CLEAN Supreme 2/28-54	28	94	84	0.10
22. CLEAN Supreme 2/28-54	28	94	84	0.10
23. CLEAN Supreme 2/28-54	28	94	84	0.10
24. CLEAN Supreme 2/28-54	28	94	84	0.10
25. CLEAN Supreme 2/28-54	28	94	84	0.10
26. CLEAN Supreme 2/28-54	28	94	84	0.10
27. CLEAN Supreme 2/28-54	28	94	84	0.10
28. CLEAN Supreme 2/28-54	28	94	84	0.10
29. CLEAN Supreme 2/28-54	28	94	84	0.10
30. CLEAN Supreme 2/28-54	28	94	84	0.10
31. CLEAN Supreme 2/28-54	28	94	84	0.10
32. CLEAN Supreme 2/28-54	28	94	84	0.10
33. CLEAN Supreme 2/28-54	28	94	84	0.10
34. CLEAN Supreme 2/28-54	28	94	84	0.10
35. CLEAN Supreme 2/28-54	28	94	84	0.10
36. CLEAN Supreme 2/28-54	28	94	84	0.10
37. CLEAN Supreme 2/28-54	28	94	84	0.10
38. CLEAN Supreme 2/28-54	28	94	84	0.10
39. CLEAN Supreme 2/28-54	28	94	84	0.10
40. CLEAN Supreme 2/28-54	28	94	84	0.10
41. CLEAN Supreme 2/28-54	28	94	84	0.10
42. CLEAN Supreme 2/28-54	28	94	84	0.10
43. CLEAN Supreme 2/28-54	28	94	84	0.10
44. CLEAN Supreme 2/28-54	28	94	84	0.10
45. CLEAN Supreme 2/28-54	28	94	84	0.10
46. CLEAN Supreme 2/28-54	28	94	84	0.10
47. CLEAN Supreme 2/28-54	28	94	84	0.10
48. CLEAN Supreme 2/28-54	28	94	84	0.10
49. CLEAN Supreme 2/28-54	28	94	84	0.10
50. CLEAN Supreme 2/28-54	28	94	84	0.10



Online product information

2D CAD data: DWG, DXF

2D CAD data is available in the online catalogue. The CAD data can be found in the download area for the respective product in a DWG format.

The complete library of data in an DWG and DXF format can be retrieved on the homepage under "SERVICE" as well as "DOWNLOADS AND SOFTWARE".

[zumtobel.com/com-en/downloads.html#2D-CAD](http://zumtobel.com/com-en/downloads.html#2D-CAD)

3D CAD data: REVIT, ARCHICAD

3D CAD data is available in the online catalogue. The CAD data can be found in the download area of the relevant product in REVIT format – if this is already available for this product group.

The complete library of data in REVIT and ARCHICAD format can be retrieved on the homepage under "SERVICE" as well as "DOWNLOADS AND SOFTWARE".

[zumtobel.com/com-en/service.html#revit](http://zumtobel.com/com-en/service.html#revit)

[zumtobel.com/com-en/downloads.html#archicad](http://zumtobel.com/com-en/downloads.html#archicad)

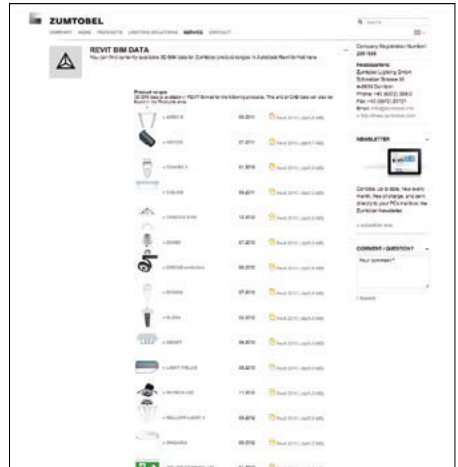



## Environmental product declaration (EPD)

The environmental product declaration (EPD) according to ISO 14025 describes the specific environmental impact of a product.

The declaration is based on the product category rules (PCR) for “luminaires, lamps and components for luminaires” set out according to EN 15804. The life cycle assessment (LCA) was prepared in compliance with ISO 14040.

The product described serves as a declared unit. An EPD includes a product description, data on material composition, manufacture, transport, period of use, disposal and recycling as well as the results of the life cycle assessment. It is subjected to independent testing according to ISO 14025.

EPDs of building products can be compared only if life cycle assessments have been calculated according to the same PCRs. This EPD refers to the IBU master EPD for the Zumtobel Group and can be called up at [bau-umwelt.de/hp4234/Luminaires-lamps.htm](http://bau-umwelt.de/hp4234/Luminaires-lamps.htm)

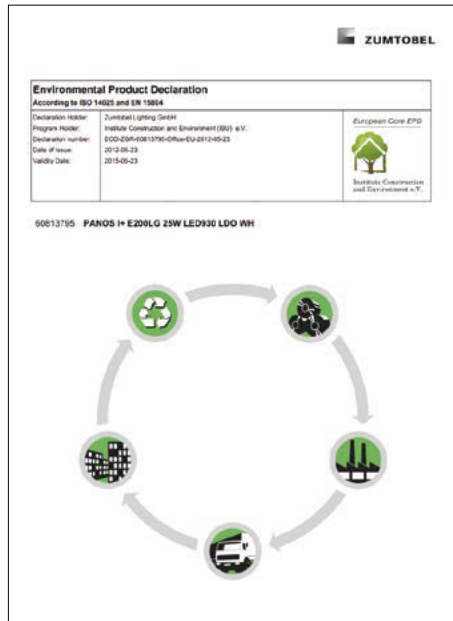

For more product information, please refer to [zumtobel.com/com-en/products](http://zumtobel.com/com-en/products)

## Map of Light

The Map of Light shows you state-of-the-art lighting solutions and impressive pictures of more than 1000 projects implemented all over the world, providing you with inspiring ideas and new stimuli for forthcoming projects.

For the Map of Light, please refer to:  
[zumtobel.com/com-en/lighting\\_solutions.asp](http://zumtobel.com/com-en/lighting_solutions.asp)

**ZUMTOBEL**  
 COMPANY NEWS PRODUCTS LIGHTING SOLUTIONS SERVICE CONTACT

MAP OF LIGHT  
 showing 1237 of 1237 projects

APPLICATION AND PRODUCT FILTERS

**LIGHTING MANAGEMENT**  
 At any time of day or night, lighting management systems provide perfect light as required. This is ensured by various components such as daylight sensors, presence detectors, dimming control systems and easy-to-use control units. In both small and large buildings, intelligent control systems save energy and enhance people's sense of well-being.

**EMERGENCY LIGHTING AND EMERGENCY LIGHTING SYSTEMS**  
 Undisturbed appearance, easy installation, low maintenance effort: These are the main features of emergency lighting by Zumtobel - whether with central or separate battery supply. In an emergency, they ensure reliable functionality without any compromise.

**OFFICES AND COMMUNICATION**  
 Spatial structures and lighting systems must be adapted to new types of work. What is required are flexible, flexible architecture and flexible light which enhances communication and motivation and improves the quality of working and spending time at the office.

**EDUCATION AND SCIENCE**  
 Using light to enhance communication, improve awareness and create social understanding, dynamic lighting solutions with optimum colour properties enhance people's concentration and improve visual comfort in educational facilities.

**PRESENTATION AND RETAIL**  
 Modern retail worlds must provide a quality of experience, their design becomes an expression of the brand message. Customised lighting solutions incorporating LED technologies are an essential element of these worlds of experience.

**HOTEL AND WELLNESS**  
 Those who collect stars for their restaurant or hotel should not only work on their services. The guests' pleasure starts with the lighting solution: light that stimulates all senses and makes guests feel at ease - thanks to spotlights, recessed luminaires, light lines or innovative LED solutions.

**ART AND CULTURE**  
 Where the highest architectural requirements must be met, even greater demands are also made on light as an enabling, accentuating factor of experience, high-quality products and the latest LED technology for pure enjoyment of art.

**BROCHURES**

- Added value through lighting management (pdf/6.0 MB)
- Emergency lighting and emergency lighting systems (pdf/4 MB)
- Light for Education and Science (pdf/6.6 MB)
- Light for Presentation and Retail (pdf/10.0 MB)
- Light for Home and Wellness (pdf/6 MB)
- Light for Art and Culture (pdf/3.3 MB)
- Light for Health and Care (pdf/5.5 MB)
- Light for Industry and engineering (pdf/9.7 MB)
- Light for Offices and architecture (pdf/3.3 MB)

**KNOWLEDGE DELIVERED FREE TO YOUR DOOR**

Subscribe to the Zumtobel Newsletter for the latest application know-how and details of inspiring projects every month. Now includes an exclusive welcome pack!

E-mail:

Send

**COMMENT / QUESTION?**

Your comment:

Submit

























**United Kingdom**

ZG Lighting (UK) Limited  
Chiltern Park  
Chiltern Hill, Chalfont St. Peter  
Buckinghamshire SL9 9FG  
T +44/(0)1388 420 042  
info.uk@zumtobelgroup.com  
zumtobel.co.uk

**USA and Canada**

Zumtobel Lighting Inc.  
3300 Route 9W  
Highland, NY 12528  
T +1/845/691 6262  
F +1/845/691 6289  
info.us@zumtobelgroup.com  
zumtobel.us

**Australia**

ZG Lighting Australia Pty. Ltd.  
2/7 Millner Avenue,  
Horsley Park, NSW 2175  
T +61/1300 139965  
info.au@zumtobelgroup.com  
zumtobel.com.au

**New Zealand**

ZG Lighting (NZ) Limited  
27 Jomac Place,  
Avondale, Auckland 1026  
PO Box 71 134, Rosebank,  
Auckland 1348  
T 0800 800 834  
T +64/(9) 828 7155  
F +64/(9) 820 7591  
info.nz@zumtobelgroup.com  
zumtobel.co.nz

**China**

Thorn Lighting (Guangzhou) Limited  
12A Lian Yun Road  
Eastern Section,  
GETDD, Guangzhou  
510530, P.R. China  
T +86(20)2232 6000  
Sales Hotline: 400 8080 195  
info.cn@zumtobelgroup.com  
zumtobel.cn

**Hong Kong**

ZG Lighting Hong Kong Ltd.  
Unit 503 – 508, 5/F, Building 16W,  
Phase 3, Hong Kong Science Park,  
New Territories, Hong Kong  
T +852/(0)2578 4303  
F +852/(0)2887 0247  
info.hk@zumtobelgroup.com

**Singapore**

ZG Lighting Singapore Pte. Ltd.  
158 Kallang Way # 06-01/02  
Singapore 349245  
T +65/6844 5800  
F +65/6745 7707  
info.sg@zumtobelgroup.com

**United Arab Emirates**

ZG Gulf LLC  
4B Street, Al Quoz industrial area 1,  
P.O.Box: 22672, Dubai,  
United Arab Emirates  
T +971 4 340 4646  
info.ae@zumtobelgroup.com  
thornlighting.ae

**Qatar**

ZG Lighting Trading WLL  
Abdul Jaleel Business Centre, Office  
No. 304, Najma Airport road  
P.O.Box: 6026  
Doha, Qatar  
T +974 4 432 1445  
info.qa@zumtobelgroup.com  
thornlighting.ae

**Romania**

Zumtobel Lighting Romania SRL  
Radu Greceanu Street, no. 2,  
Ground Floor, sector 1  
012225 Bucharest  
T +40 31225 38 01  
F +40 31225 38 04  
info.ro@zumtobelgroup.com  
zumtobel.com

**Hungary**

ZG Lighting Hungary Kft.  
Váci út 49  
1134 Budapest  
T +36/(1) 450 2490  
F +36/(1) 350 0829  
info.hu@zumtobelgroup.com  
zumtobel.hu

**Croatia**

ZG Lighting d.o.o.  
Ulica Petra Hektorovića 2  
10000 Zagreb  
T +385/(1) 64 04 080  
F +385/(1) 64 04 090  
info.hr@zumtobelgroup.com

**Bosnia and Herzegovina**

ZG Lighting d.o.o.  
Predstavništvo u BiH  
Zmaja od Bosne 7  
71000 Sarajevo  
T +387 33 590 463  
info.ba@zumtobelgroup.com

**Serbia**

ZG Lighting d.o.o.  
Beton hala – Karadorđeva 2-4  
11000 Belgrade  
M+381 69 54 44 802  
info.rs@zumtobelgroup.com

**Czech Republic**

ZG Lighting Czech Republic s.r.o.  
Jankovcova 2  
Praha 7  
170 00 Praha  
T +420 266 782 200  
F +420 266 782 201  
info.cz@zumtobelgroup.com  
zumtobel.cz

**Slovak Republic**

ZG Lighting Slovakia s.r.o.  
Tomášikova 64  
831 04 Bratislava  
T +421 2 2030 0044  
info.sk@zumtobelgroup.com  
zumtobel.sk

**Poland**

ZG Lighting Polska Sp. z o.o.  
Woloska 9a  
Platinum Business Park III  
02-583 Warszawa  
T +48 22 856 74 31  
info.pl@zumtobelgroup.com  
zumtobel.pl

**Slovenia**

ZG Lighting d.o.o  
Štukljeva cesta 46  
1000 Ljubljana  
T +386/(1) 5609 820  
F +386/(1) 5609 866  
info.si@zumtobelgroup.com  
zumtobel.si

**Russia**

ZG Svet JSC  
Official office Zumtobel Group  
Nizhnij Susalniy pereulok,  
5/19, office 405  
105064 Moscow  
T +7/(495) 981 35 41  
T +7/(812) 604 02 60  
info.ru@zumtobelgroup.com  
zumtobel.ru

**Norway**

ZG Lighting Norway AS  
Bygdøy allé 4  
0257 Oslo  
T +47 22 54 72 00  
info.no@zumtobelgroup.com  
zumtobel.no

**Sweden**

ZG Lighting Nordic AB  
Hyllie Boulevard 10b  
215 32 Malmö  
T +46 649 20 00  
info.se@zumtobelgroup.com  
zumtobel.se

**Denmark**

ZG Lighting Denmark A/S  
Stamholmen 155, 5. sal  
2650 Hvidovre  
T +45 35 43 70 00  
info.dk@zumtobelgroup.com  
zumtobel.dk



**Headquarters**

Zumtobel Lighting GmbH  
Schweizer Strasse 30  
Postfach 72  
6851 Dornbirn, AUSTRIA  
T +43/(0)5572/390-0  
info@zumbel.info

**zumbel.com**

Order no. 04 797 525-EN 04/18 © Zumtobel Lighting GmbH  
Technical data was correct at time of going to press.  
We reserve the right to make technical changes without  
notice. Please contact your local sales office for further  
information.

ISBN 978-3-902940-72-8